

Vintner Series

rev. 9/24/08

Diamond Bin With Face Trim

Parts List

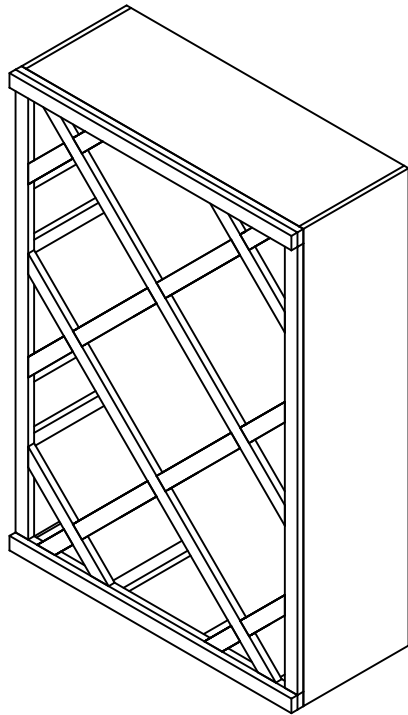

qty.	description
2	(1 each) Top/ Bottom
2	Sides
4	(2 each) Top/ Bottom Trim
2	Side Trim
4	1 Notch Face Trim
4	3 Notch Face Trim
1	Bag of Nails
1	Patch stick
1	Screw Driver Bit
12	1 5/8" #6 screws
1	Hardware Pack containing 2 1" corner brace 2 plastic anchors 2 1"#8 screws 2 5/8"#6 screws
X-Interlock boards	
8 total boards	4 1 Notch 4 3 Notched

X-Interlocks

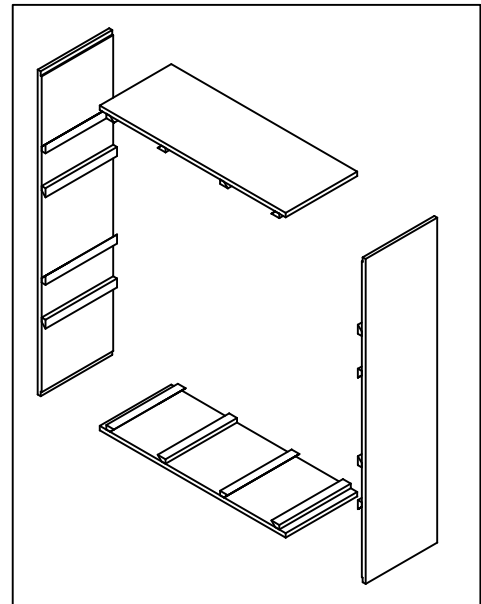
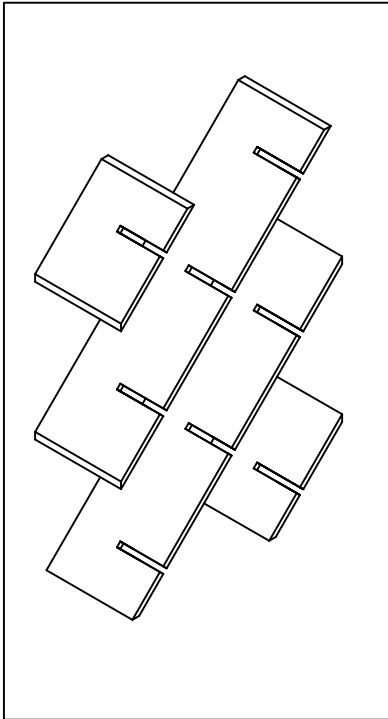

Trim

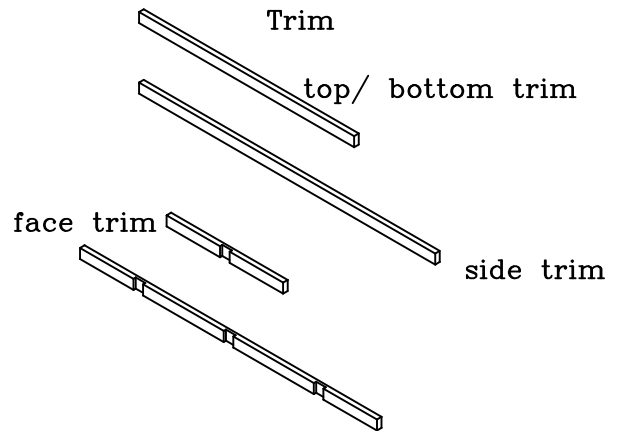

Wine Cellar Innovations

4575 Eastern Avenue
Cincinnati, Ohio 45226

Phone: (800) 229-9813

Fax: (513) 979-5280

www.winecellarinnovations.com

1. Attach the top, bottom, and sides together with the 1 5/8" #6 screws.

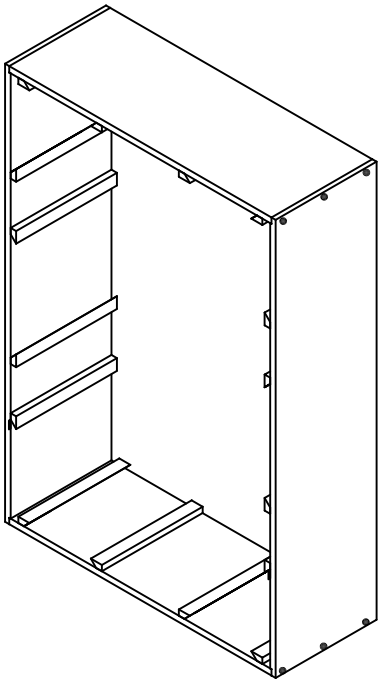

2. Insert 1/2 of interlock boards into termination blocks, notches on interlock boards should face front.

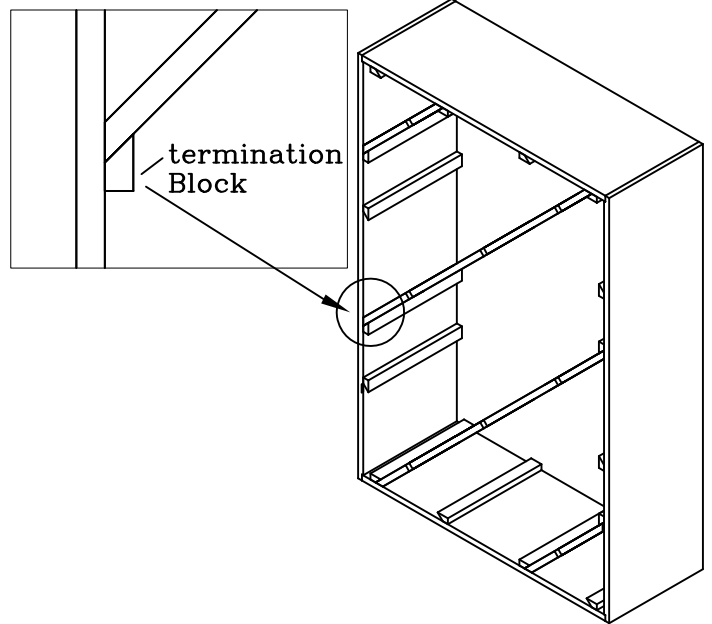

3. Insert remaining interlock boards into termination blocks, notches on interlock boards should face wall.

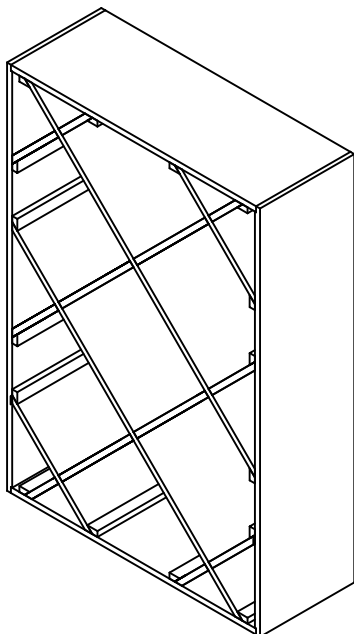

4. Measure top, middle and bottom of Diamond bin, to prevent gaps in trim all three must equal 32 7/8". Be sure to maintain 32 7/8" dimension while attaching trim.

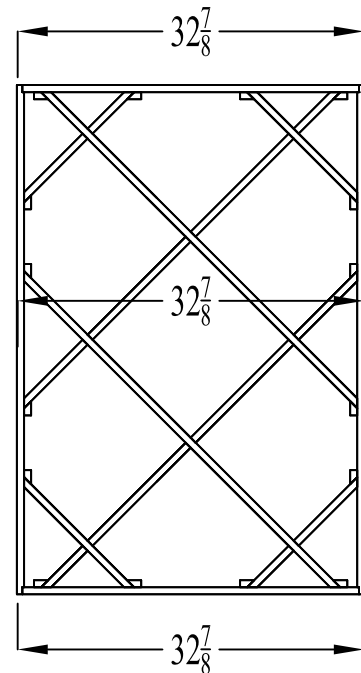

5. Attach Perimeter Trim. At each interlock nail through frame (top, bottom, sides) and interlock.

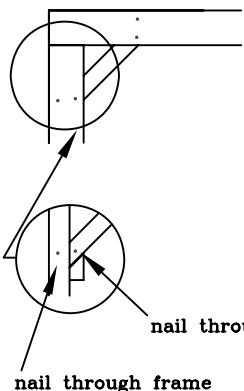

The additional pieces of top/bottom trim will be used in step: 7

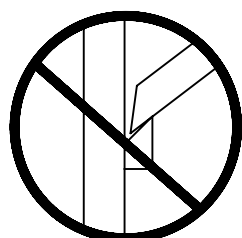
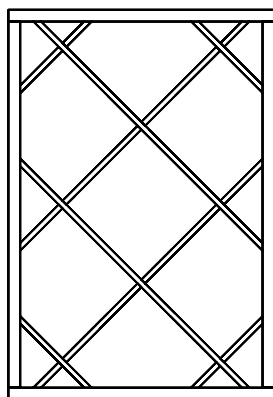

There should be no gaps between interlocks and frame. If gaps occur, measure top, bottom, and middle as in step:4.

6. Nail interlocking face trim to x-interlocks. see "Diamond Face Trim Detail"

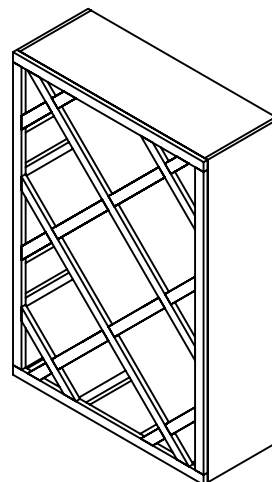

7. Attach second top trim piece with nails.

If kit is going to be stacked with another kit follow trim kit instructions before attaching bottom trim. If not then attach bottom trim piece with nails.

side view

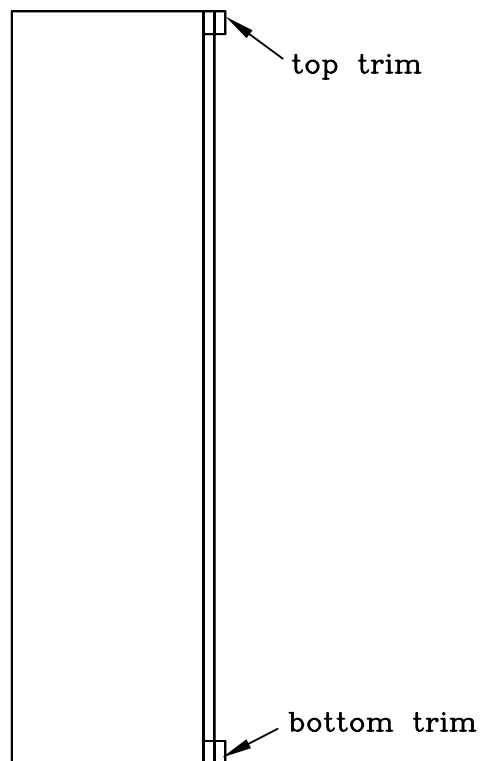

Diamond Face Trim Detail

Face trim is applied after the diamond bin is assembled with perimeter trim (top, bottom, sides) attached. Diamond bins can either be standing upright or laying flat on the floor, though the process in most instances would be easier flat on the floor.

There will be 1 piece of face trim for each of the interlock boards. The notches on face trim boards match the dadoes on the interlock boards. Face trim boards are sent approximately 3" long on either end to be cut to fit on site by contractor. This is done to prevent gaps and insure a tight fit.

Step 1: With notches facing up lay 1 face trim piece on half of interlock boards(see below). Notches on face trim should be lined up with dadoes on interlocks. When you are satisfied with alignment, mark the point at which the face trim intersects the perimeter trim.

Step 2: Miter cut ends of face trim at the marked line.

Step 3: Nail cut face trim boards to one half of interlocks, Repeat procedure for remaining interlocks

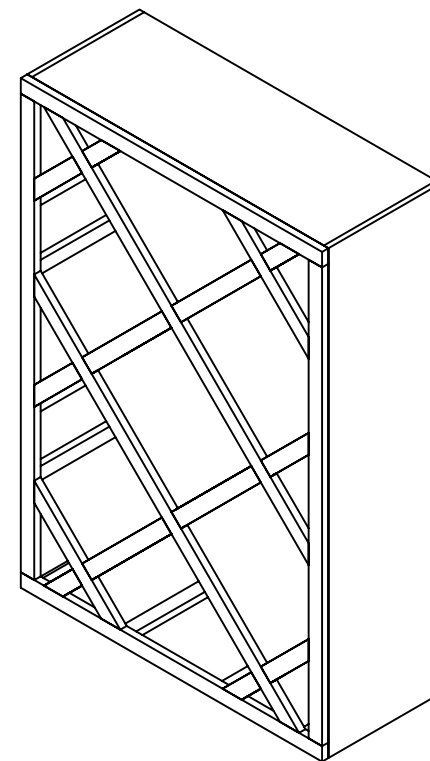
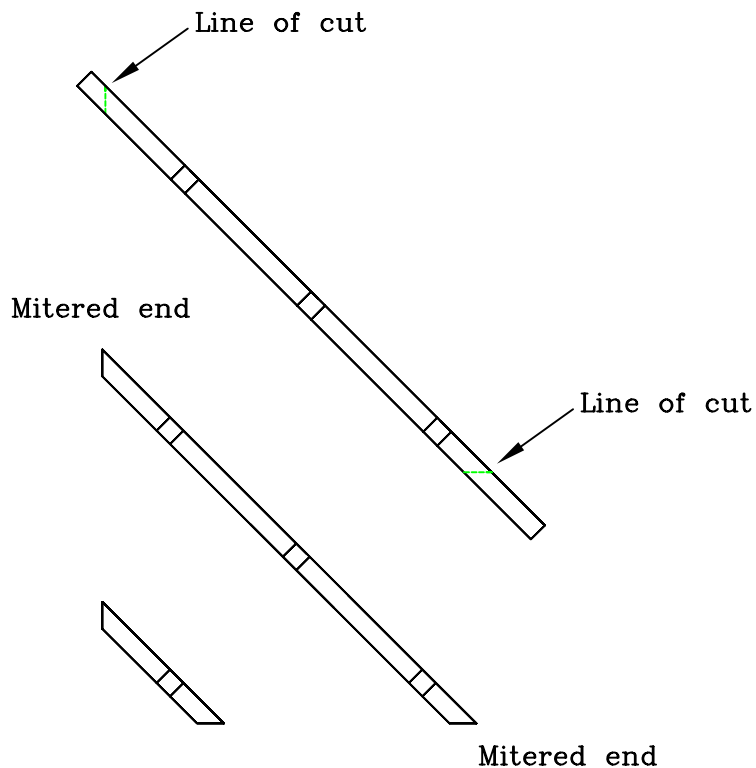
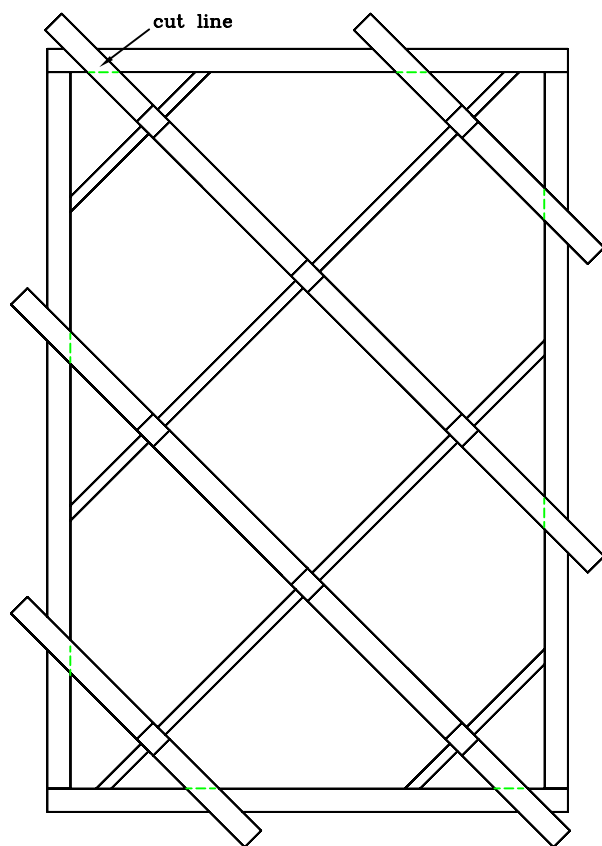

Note: If you happen to miter face trim incorrectly Wine Cellar Innovations will replace free of charge.

Phone: (800) 229-9813

Fax: (513) 979-5280

www.winecellarinnovations.com

Final Step

Securing to wall

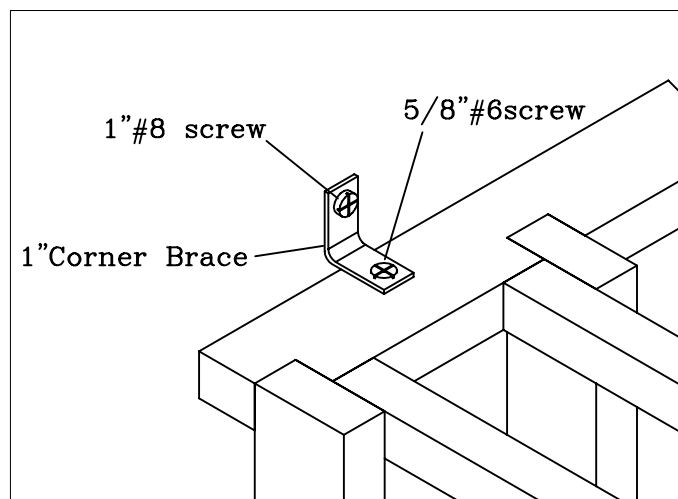

Note: due to ceiling height restrictions it may be necessary to attach Corner brace on under side of Spacer bar.

Secure rack to wall by attaching 1"corner brace to top back spacer bar (or solid top) of unit. You will have 1 brace on the left and 1 on the right.

If you are securing a kit that is stacked on top of another unit follow the instructions for installing trim kit before attaching to wall.

Attach the corner braces to one of the middle spacer bars, if you have a bin unit or diamond cube unit that will have other racks stacked on top of it.