

Vintner Series Assembly Manual

for 1, 2, 3, 4, 5 & 10 columns with Display

****3 column shown throughout the manual****

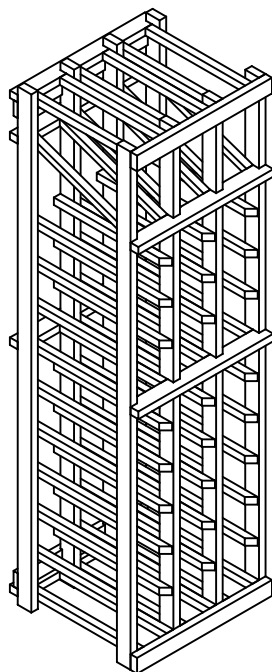

VIN-IND3DS

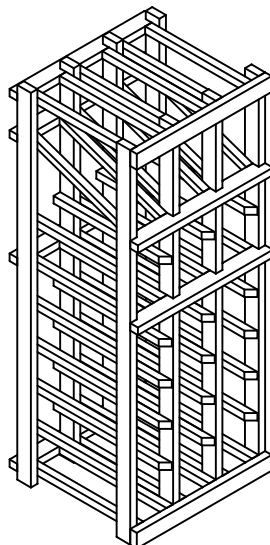

VIN3-IND3DS

VINTNER 4FT CODES:

VIN-**-**-IND1DS
VIN-**-**-IND2DS
VIN-**-**-IND3DS
VIN-**-**-IND4DS
VIN-**-**-IND5DS
VIN-**-**-IND10DS

VINTNER 3FT CODES:

VIN3-**-**-IND1DS
VIN3-**-**-IND2DS
VIN3-**-**-IND3DS
VIN3-**-**-IND4DS
VIN3-**-**-IND5DS
VIN3-**-**-IND10DS

Note:

The VIN-IND3DS is detailed in this manual however the assembly procedure for VIN-IND3DS and VIN3-IND3DS kit is the same.

Industry Leading Replacement Policy :

If during transit or assembly you should break or damage any of the parts you may contact us within 90 days of the ship date and we will ship you a replacement part via ground transportation at no additional cost to you.

PARTS LIST

VIN3&4-IND1DS

| # | qty. | description |
|---|------|-------------------------|
| A | 6 | 2 notch Spacerbars |
| B | 2 | Back Brace |
| C | 2 | Top/Bottom Trims |
| D | 2 | Stackable Beam Supports |
| E | 1 | Left Rack |
| G | 1 | Right Rack |

VIN3&4-IND2DS

| # | qty. | description |
|---|------|-------------------------|
| A | 6 | 3 notch Spacerbars |
| B | 2 | Back Brace |
| C | 2 | Top/Bottom Trims |
| D | 2 | Stackable Beam Supports |
| E | 1 | Left Rack |
| F | 1 | Double Rack |
| G | 1 | Right Rack |

VIN3&4-IND3DS

| # | qty. | description |
|---|------|-------------------------|
| A | 6 | 4 notch Spacerbars |
| B | 2 | Back Brace |
| C | 2 | Top/Bottom Trims |
| D | 2 | Stackable Beam Supports |
| E | 1 | Left Rack |
| F | 2 | Double Rack |
| G | 1 | Right Rack |

VIN3&4-IND4DS

| # | qty. | description |
|---|------|-------------------------|
| A | 6 | 5 notch Spacerbars |
| B | 2 | Back Brace |
| C | 2 | Top/Bottom Trims |
| D | 2 | Stackable Beam Supports |
| E | 1 | Left Rack |
| F | 3 | Double Rack |
| G | 1 | Right Rack |

VIN3&4-IND5DS

| # | qty. | description |
|---|------|-------------------------|
| A | 6 | 6 notch Spacerbars |
| B | 2 | Back Brace |
| C | 2 | Top/Bottom Trims |
| D | 2 | Stackable Beam Supports |
| E | 1 | Left Rack |
| F | 4 | Double Rack |
| G | 1 | Right Rack |

VIN3&4-IND10DS

| # | qty. | description |
|---|------|-------------------------|
| A | 6 | 11 notch Spacerbars |
| B | 2 | Back Brace |
| C | 2 | Top/Bottom Trims |
| D | 2 | Stackable Beam Supports |
| E | 1 | Left Rack |
| F | 9 | Double Rack |
| G | 1 | Right Rack |

NOTE : ALL RACK PARTS WILL INCLUDE :

- * 1 Hardware Pack containing
- * 1 Bag of Nails
- 2 L Brackets
- 2 Plastic anchors
- 2 1" #8 screws
- 2 5/8" #6 screws

IND1DS

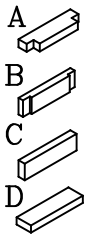

IND2DS

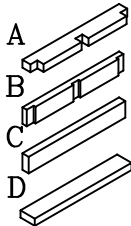

IND3DS

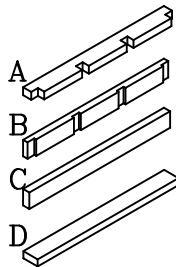

IND4DS

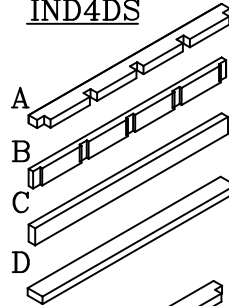

IND5DS

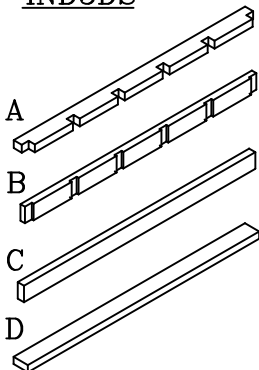

IND10DS

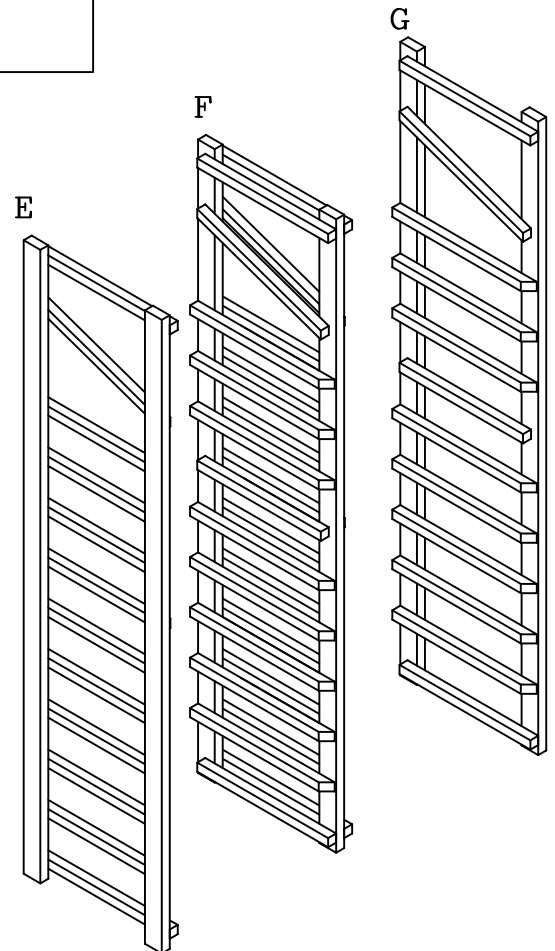
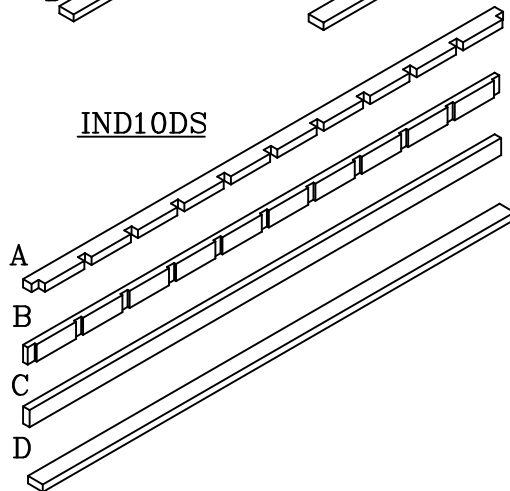

1. Attach (4) spacer bars to the back of the racks with nails. Top & bottom spacer bars should only have a nail on each end, the middle spacer bar should have a nail in each notch. This can be done with the provided nails or with a brad nailer.

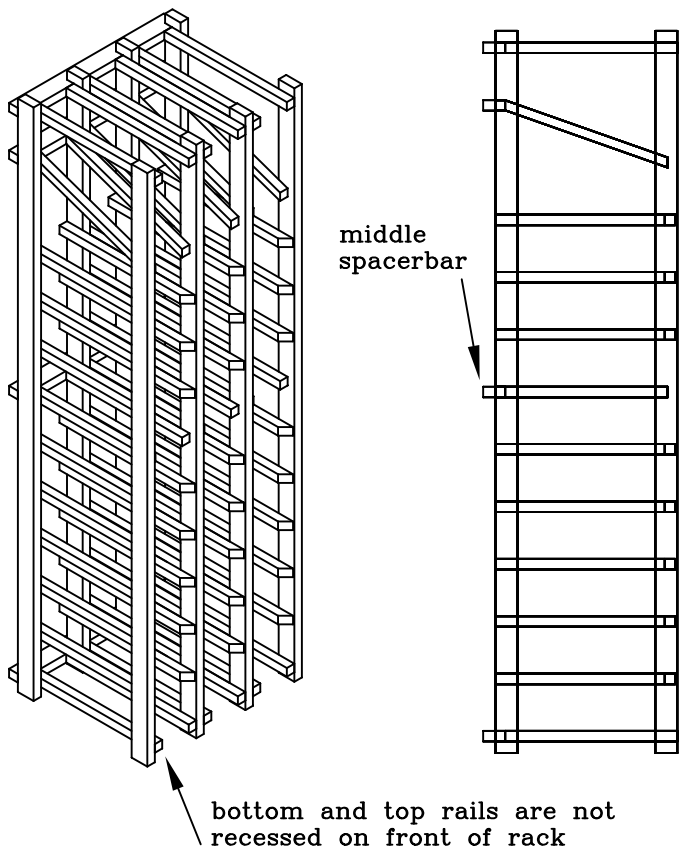

2. Attach 1 Back Brace below Top Rear Spacerbar and another Brace on Top of Bottom Spacerbar. Same way as Step 1.

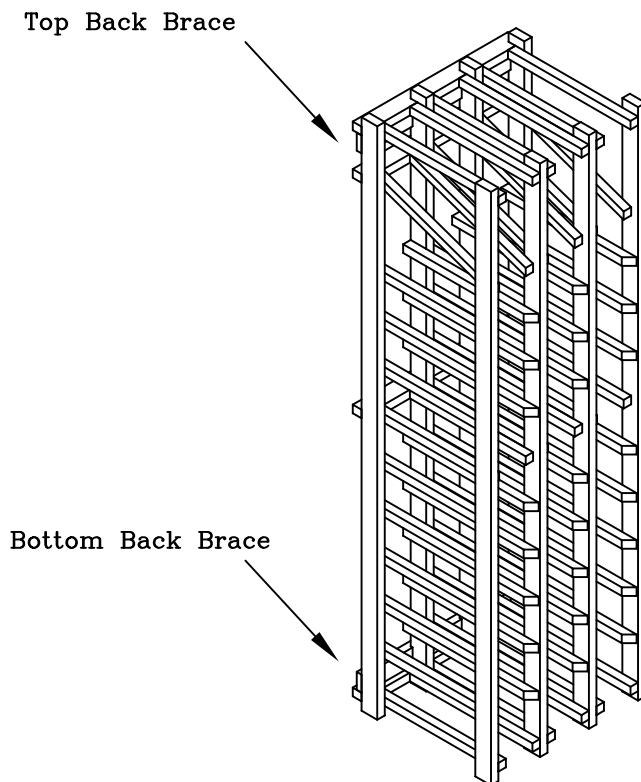

3. Attach (2) spacer bars to the front of the racks by nailing through the end notches.

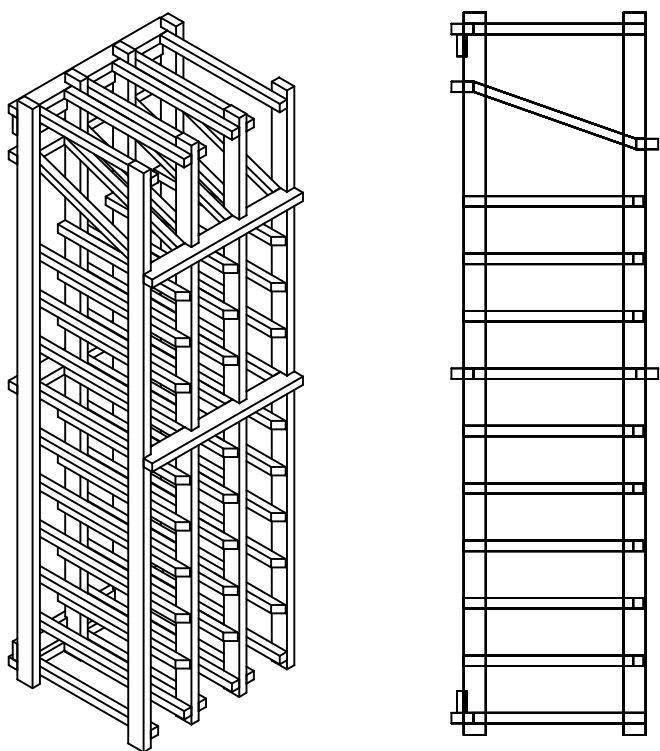

3. Attach top trim to front of racks with nails provided. If unit is not going to be stacked on top of another kit then attach bottom trim as well. If unit is going to be stacked on top of another kit then follow the trim kit instructions before attaching the bottom trim board.

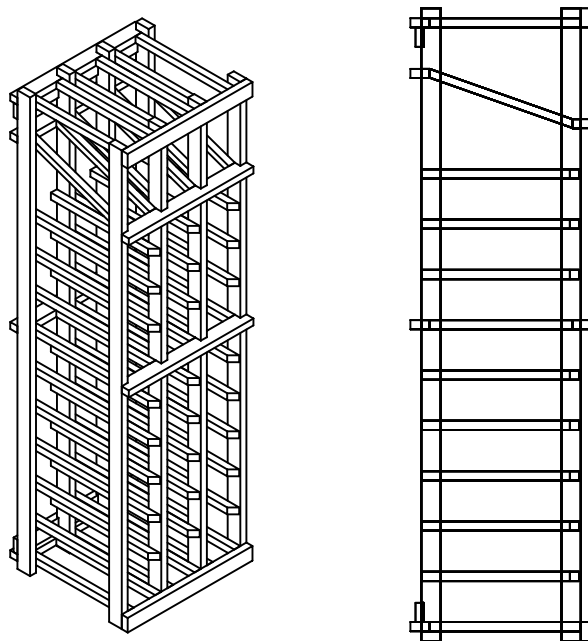

Final Step

Secure to the Wall

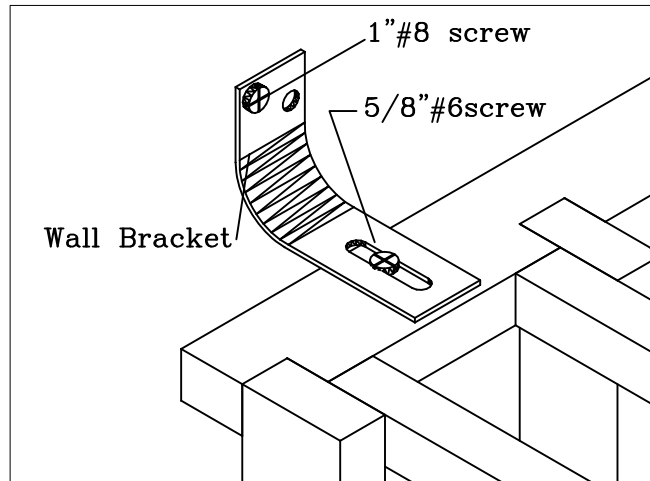

Secure rack to wall by attaching wall brackets to top back spacer bar or solid top. You will have 1 bracket on the left and 1 on the right.

Wine Rack is Complete

Note : Always remove bottles before moving rack