

Winemaker Series

WATER3 (L)

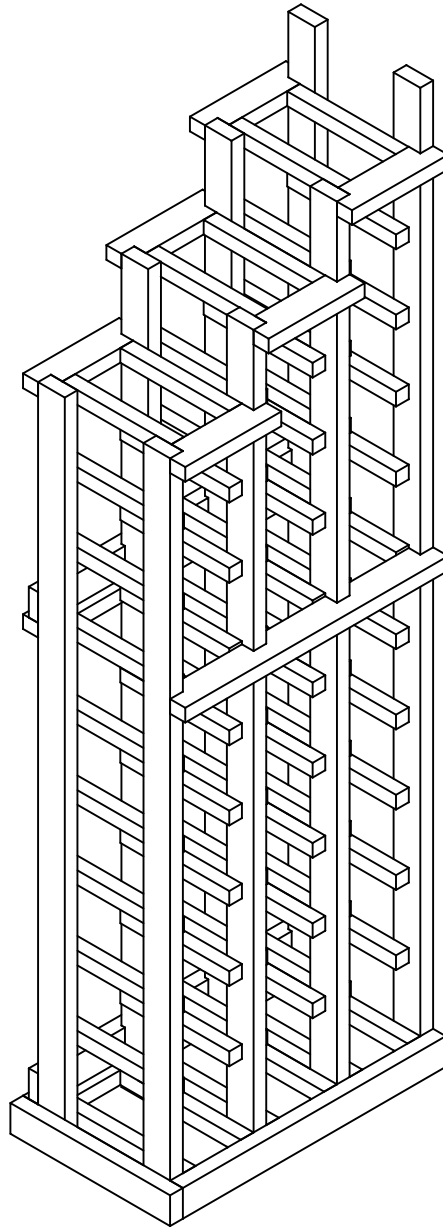

Industry Leading Replacement Policy :

If during transit or assembly you should break or damage any of the parts you may contact us within 90 days of the ship date and we will ship you a replacement part via ground transportation at no additional cost to you.

Wine Cellar Innovations
4575 Eastern Avenue
Cincinnati, Ohio 45226

Phone: (800) 229-9813
Fax: (513) 979-5280
www.winecellarinnovations.com

WATER3 (L)

Parts List

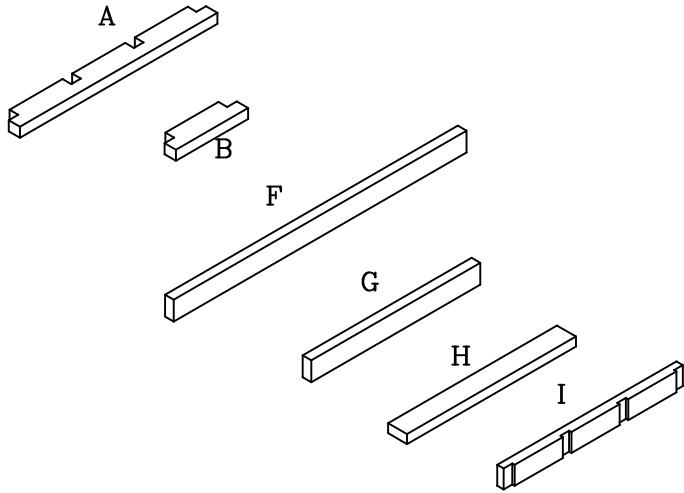

#	qty.	description
A	3	Spacer Bar#1
B	6	Spacer Bar#2
C	1	Right
D	2	Waterfall Commons
E	1	Left
F	1	Front trim
G	1	Side trim
H	2	Stackable Beam Supports
I	2	Top/Bottom Back Brace
*	1	Hardware Pack containing
*	1	Bag of nails
		2 L brackets
		2 plastic anchors
		2 1" #8 screws
		2 5/8" #6 screws

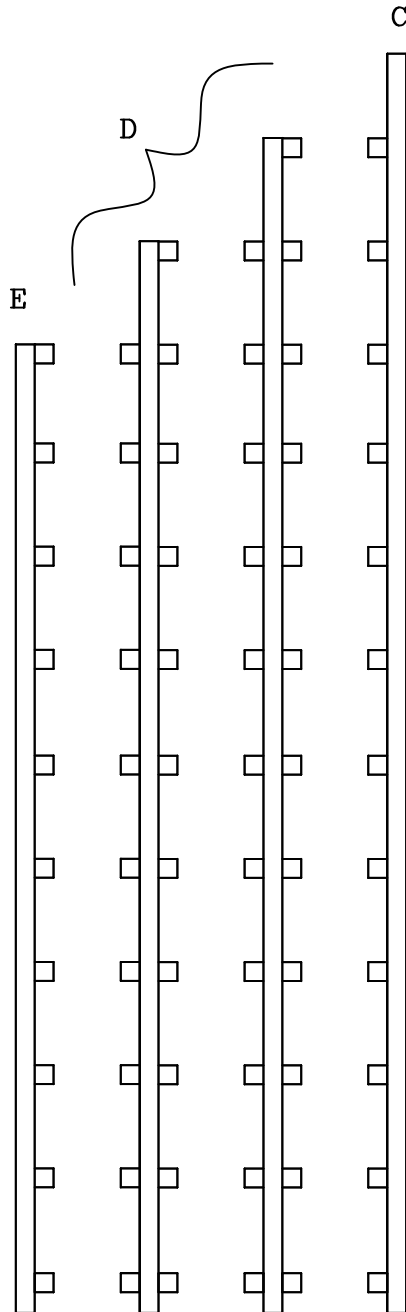

1. Attach (2) spacer bar#1 and (3) spacer bar#2's to the back of Right and Left and (2) waterfall common's with nails.
Nail through each notch in spacer bars into post. This can be done with the provided nails or with a brad nailer.

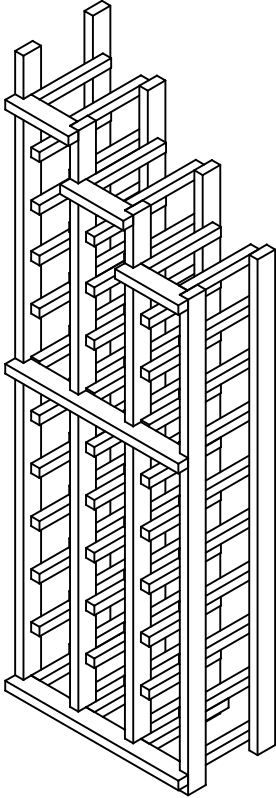

2. Attach 1 Bottom Back Brace above Rear Bottom and middle Spacerbars.

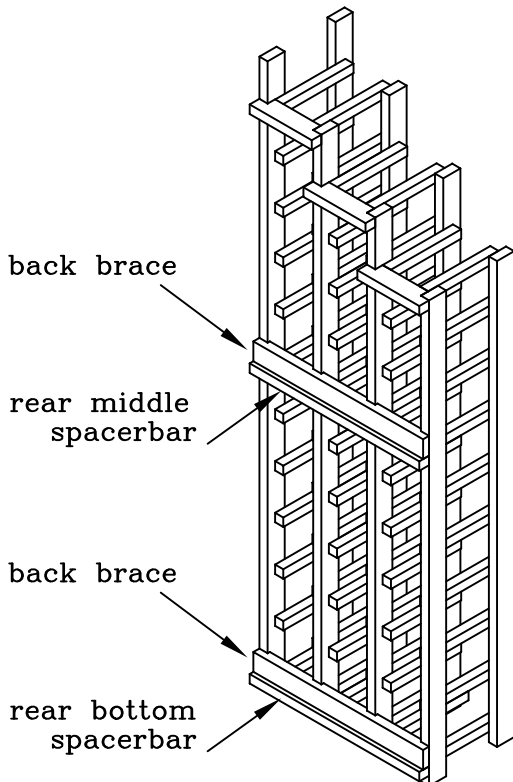

* Always remove all bottles before moving Racks.

3. Attach (1) spacer bar#1, (3) spacer bar#2 and front trim to racks. Attach side trim only if there are no adjoining racks or decorative moldings being attached.

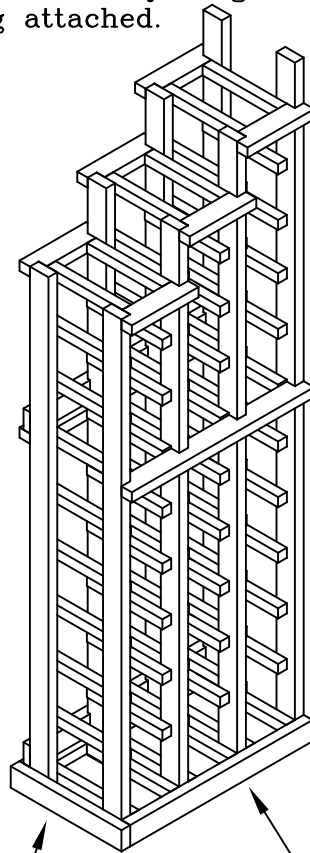

Attach side trim*

Attach front trim

Final Step

Secure rack to wall by attaching wall brackets to top back spacer bar. You will have 1 bracket on the left and 1 on the right.

NOTE : A distance of $1\frac{1}{2}$ " should be followed from the wall to the back of the Wine Rack

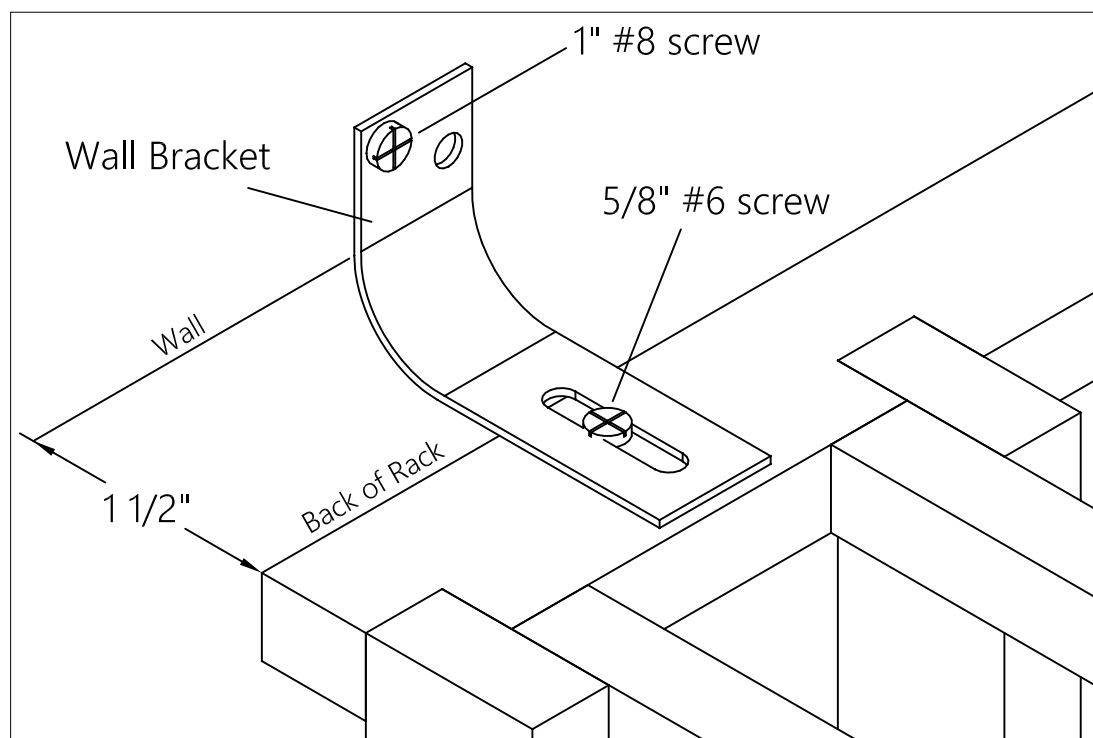

RACK ASSEMBLY IS COMPLETE.
Always remove bottles before moving racks.

For more info

Watch Assembly Videos in our Video Gallery at www.WineCellarInnovations.com