

# Winemaker Series

WMK3&4-MAG

\*4 ft. version shown throughout manual. 3 ft. assembly is the same.

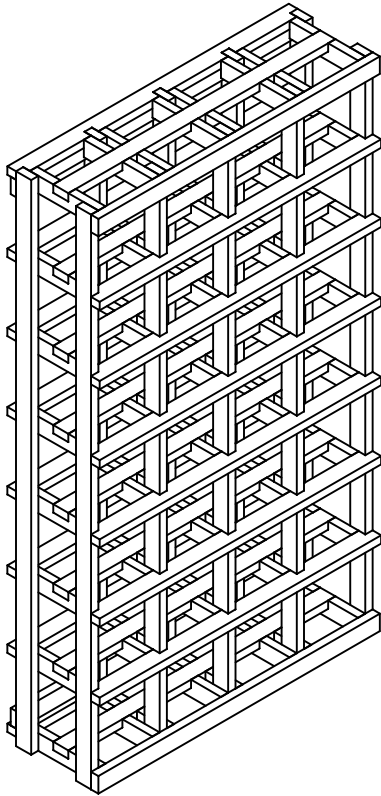

## Industry Leading Replacement Policy :

**If during transit or assembly you should break or damage any of the parts you may contact us within 90 days of the ship date and we will ship you a replacement part via ground transportation at no additional cost to you.**

### Parts List

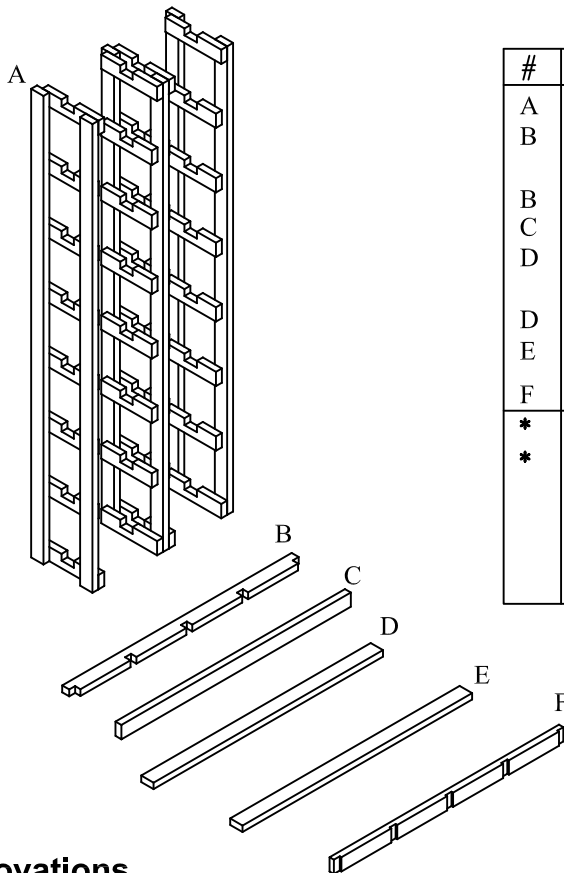

#	qty.	description
A	5	Racks-1 left, 1 right, 3 doubles
B	14	Spacer bars (4ft version)
	<u>OR</u>	
B	10	Spacer bars (3ft version)
C	2	Top/ Bottom Trim
D	8	Slats (4ft version)
	<u>OR</u>	
D	6	Slats (3ft version)
E	2	Stackable Beam Supports
F	2	Top/Bottom Back Brace
*	1	Hardware Pack containing
*	1	Bag of Nails
		2 L Brackets
		2 plastic anchors
		2 1" #8 screws
		2 5/8" #6 screws

**Wine Cellar Innovations**  
4575 Eastern Avenue  
Cincinnati, Ohio 45226

Phone: (800) 229-9813  
Fax: (513) 979-5280  
[www.winecellarinnovations.com](http://www.winecellarinnovations.com)

1. Attach spacer bars to the racks with nails. This can be done with the provided nails or with a brad nailer.

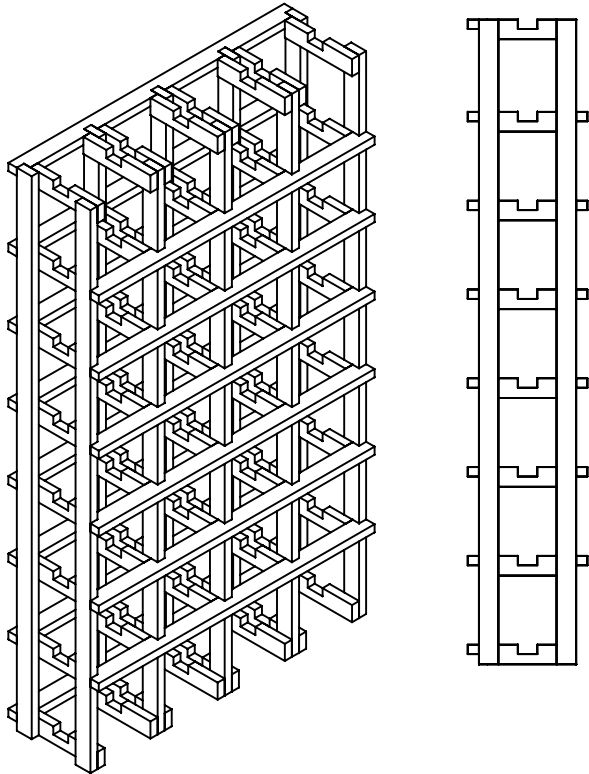

2. Attach 1 Back Brace below Top Spacerbar and 1 Back Brace above Bottom Spacerbar the same manner as step 1.

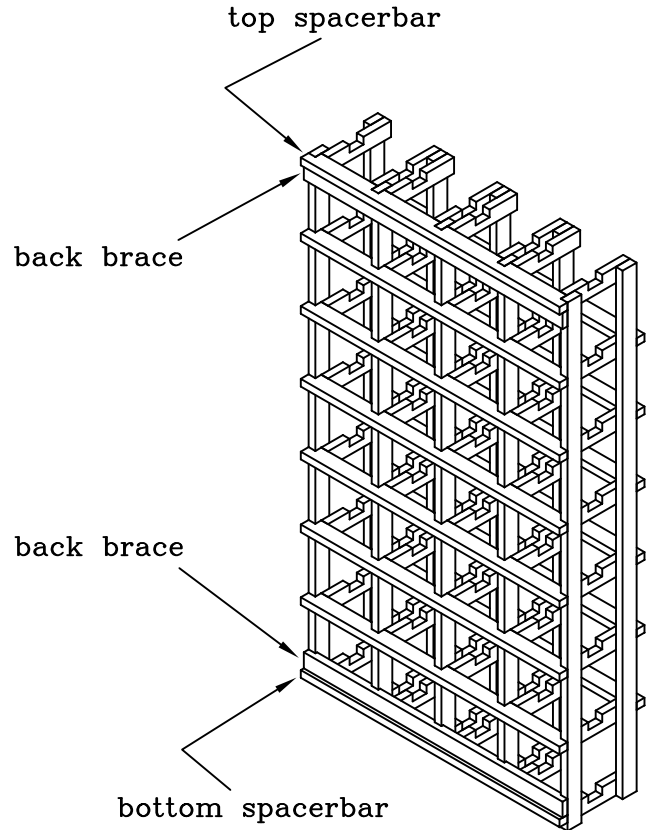

3. Attach top trim to front of racks with nails provided. If unit is not going to be stacked on top of another kit then attach bottom trim as well. If unit is going to be stacked on top of another kit then follow the trim kit instructions before attaching the bottom trim board.

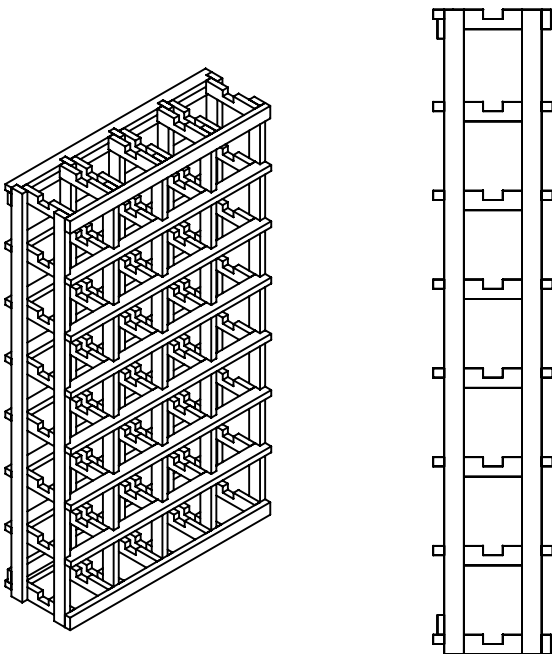

4. Insert slats into notched rails on racks. If you are stacking this kit on top of another kit then wait until the kits have been attached to insert slats.

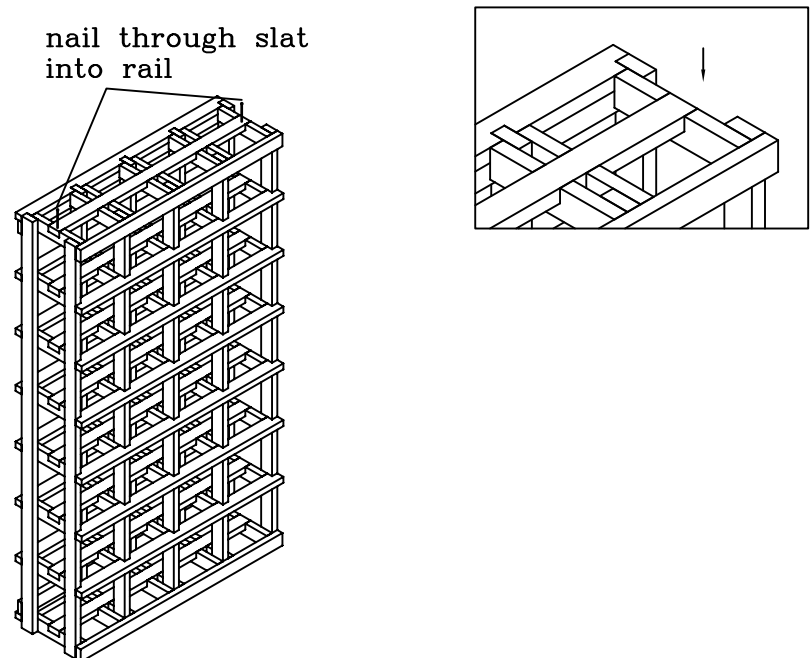

## Final Step

Secure rack to wall by attaching wall brackets to top back spacer bar. You will have 1 bracket on the left and 1 on the right.

NOTE : A distance of  $1\frac{1}{2}$ " should be followed from the wall to the back of the Wine Rack

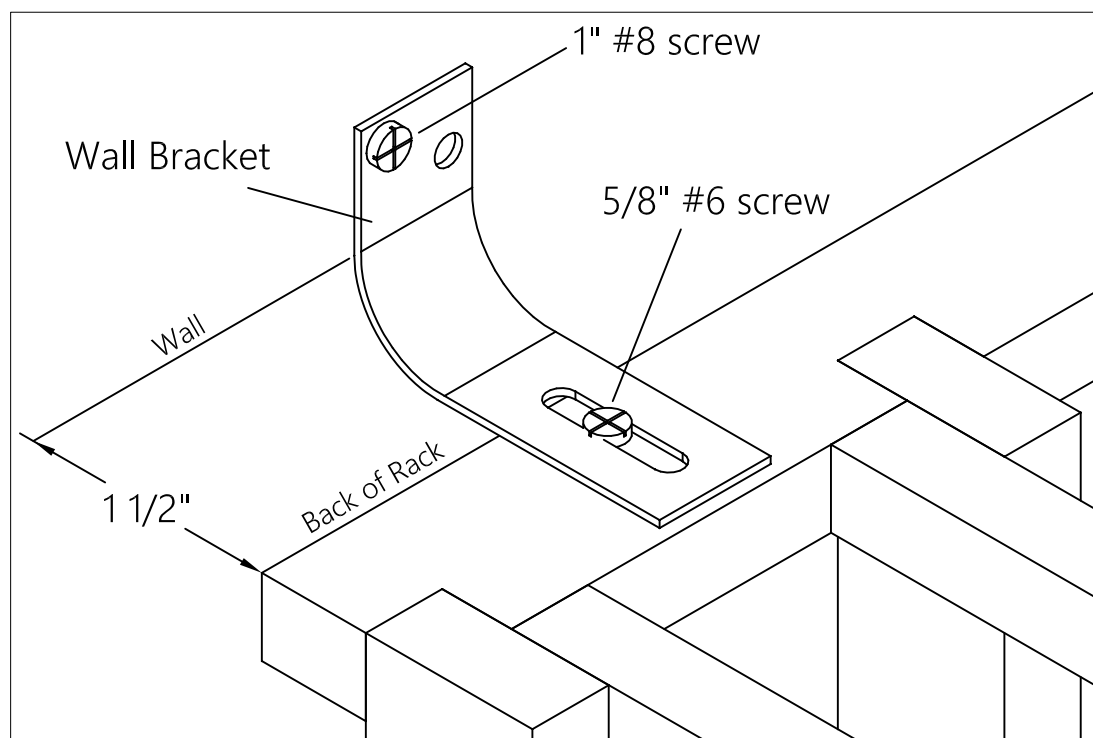

**RACK ASSEMBLY IS COMPLETE.**  
Always remove bottles before moving racks.

For more info

Watch Assembly Videos in our Video Gallery at [www.WineCellarInnovations.com](http://www.WineCellarInnovations.com)