

# Vintner and Winemaker Series Assembly Manual for 1, 2, 3, 4, 5 & 10 columns

**\*\*3 column shown throughout the manual\*\***

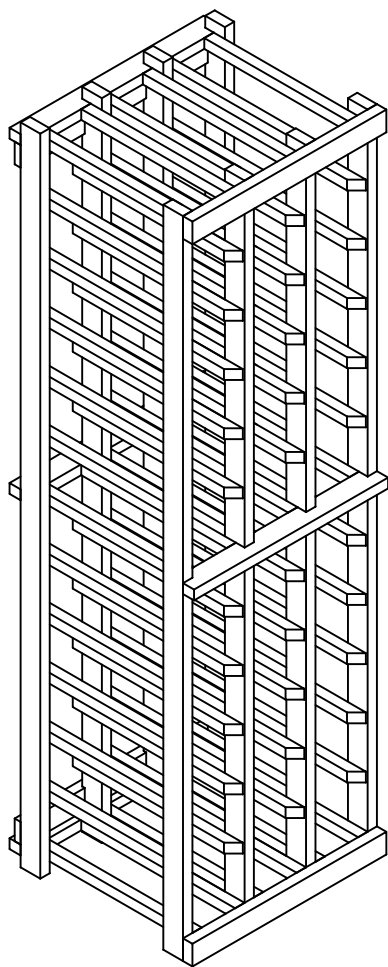

VIN3&4-IND3

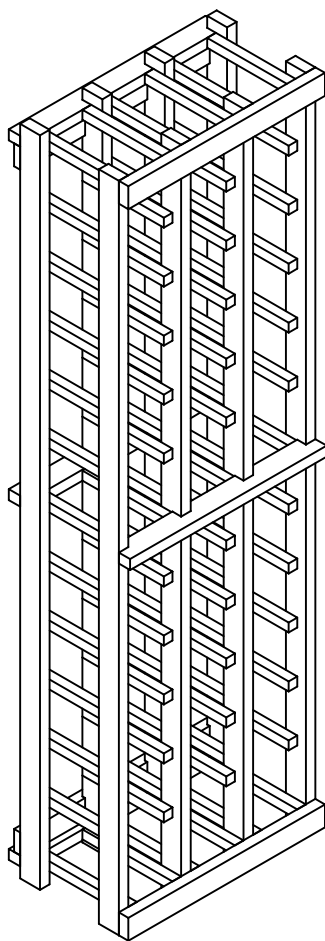

WMK3&4-IND3

#### VINTNER 4FT CODES:

VIN-\*\*-\*\*-IND1  
VIN-\*\*-\*\*-IND2  
VIN-\*\*-\*\*-IND3  
VIN-\*\*-\*\*-IND4  
VIN-\*\*-\*\*-IND5  
VIN-\*\*-\*\*-IND10

#### VINTNER 3FT CODES:

VIN3-\*\*-\*\*-IND1  
VIN3-\*\*-\*\*-IND2  
VIN3-\*\*-\*\*-IND3  
VIN3-\*\*-\*\*-IND4  
VIN3-\*\*-\*\*-IND5  
VIN3-\*\*-\*\*-IND10

#### WINEMAKER 4FT CODES:

WMK-\*\*-\*\*-IND1  
WMK-\*\*-\*\*-IND2  
WMK-\*\*-\*\*-IND3  
WMK-\*\*-\*\*-IND4  
WMK-\*\*-\*\*-IND5  
WMK-\*\*-\*\*-IND10

#### WINEMAKER 3FT CODES:

WMK3-\*\*-\*\*-IND1  
WMK3-\*\*-\*\*-IND2  
WMK3-\*\*-\*\*-IND3  
WMK3-\*\*-\*\*-IND4  
WMK3-\*\*-\*\*-IND5  
WMK3-\*\*-\*\*-IND10

## Industry Leading Replacement Policy :

If during transit or assembly you should break or damage any of the parts you may contact us within 90 days of the ship date and we will ship you a replacement part via ground transportation at no additional cost to you.

\* 4ft WMK version shown throughout manual\*

**Wine Cellar Innovations**  
4575 Eastern Avenue  
Cincinnati, Ohio 45226

Phone: (800) 229-9813  
Fax: (513) 979-5280  
[www.winecellarinnovations.com](http://www.winecellarinnovations.com)

## PARTS LIST

### VIN3&4/WMK3&4-IND1

#	qty.	description
A	4	2 notch Spacerbars
B	2	Back Brace
C	2	Square Base/Crown
D	2	Stackable Beam Supports
E	1	Left Rack
G	1	Right Rack

### VIN3&4/WMK3&4-IND2

#	qty.	description
A	4	3 notch Spacerbars
B	2	Back Brace
C	2	Square Base/Crown
D	2	Stackable Beam Supports
E	1	Left Rack
F	1	Double Rack
G	1	Right Rack

### VIN3&4/WMK3&4-IND3

#	qty.	description
A	4	4 notch Spacerbars
B	2	Back Brace
C	2	Square Base/Crown
D	2	Stackable Beam Supports
E	1	Left Rack
F	2	Double Rack
G	1	Right Rack

### VIN3&4/WMK3&4-IND4

#	qty.	description
A	4	5 notch Spacerbars
B	2	Back Brace
C	2	Square Base/Crown
D	2	Stackable Beam Supports
E	1	Left Rack
F	3	Double Rack
G	1	Right Rack

### VIN3&4/WMK3&4-IND5

#	qty.	description
A	4	6 notch Spacerbars
B	2	Back Brace
C	2	Square Base/Crown
D	2	Stackable Beam Supports
E	1	Left Rack
F	4	Double Rack
G	1	Right Rack

### VIN3&4/WMK3&4-IND10

#	qty.	description
A	4	11 notch Spacerbars
B	2	Back Brace
C	2	Square Base/Crown
D	2	Stackable Beam Supports
E	1	Left Rack
F	9	Double Rack
G	1	Right Rack

#### NOTE : ALL RACK PARTS WILL INCLUDE :

- \* 1 Hardware Pack containing
- \* 1 Bag of Nails
- 2 L Brackets
- 2 Plastic anchors
- 2 1" #8 screws
- 2 5/8" #6 screws

**\*\*WMK PROFILE SHOWN  
FOR PARTS E, F & G\*\***

#### IND1

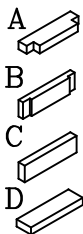

#### IND2

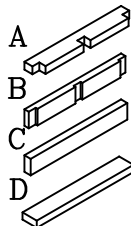

#### IND3

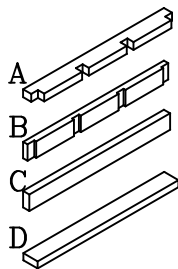

#### IND4

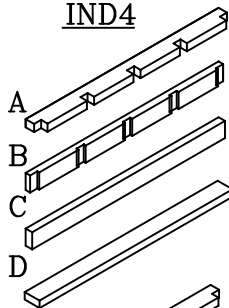

#### IND5

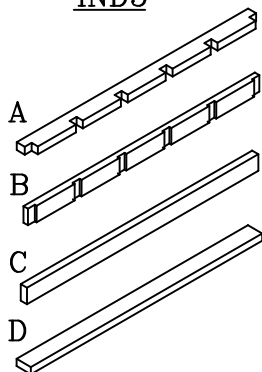

#### IND10

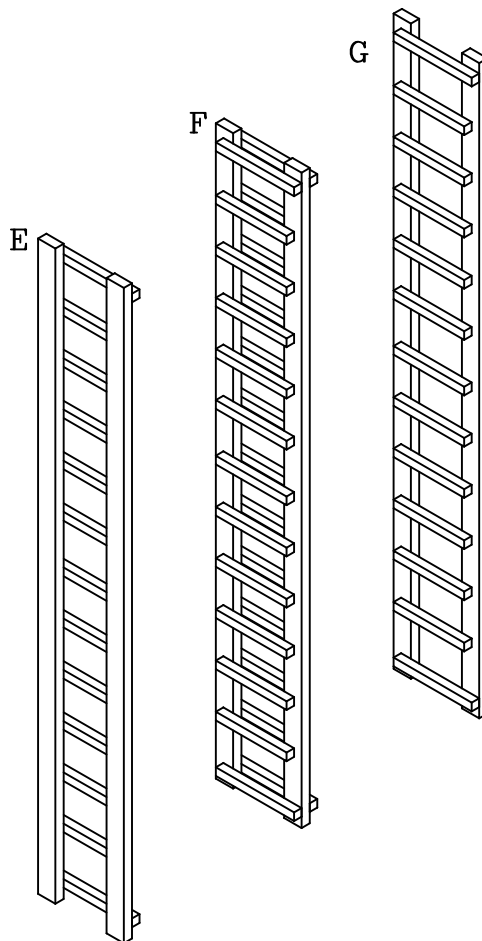
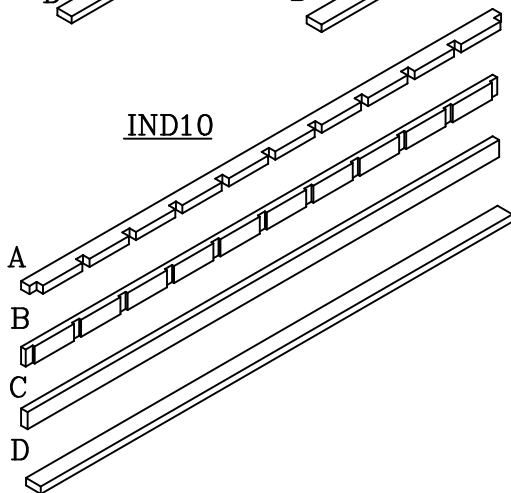

1. Attach (3) spacerbars to the back of the racks with nails. Note, the middle spacerbar is placed on the 7th rail from the bottom for the 4ft. version or the 6th rail from the bottom for the 3ft. version.

Top & bottom spacer bars should only have a nail on each end, the middle spacer bar should have a nail in each notch. This can be done with the provided nails or with a brad nailer.

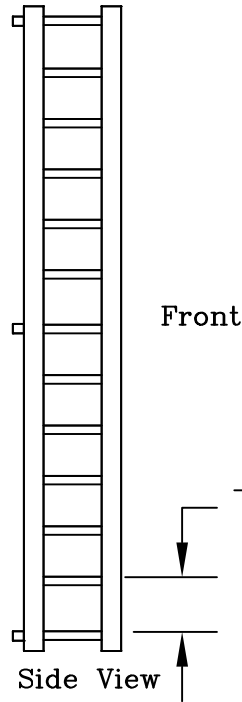
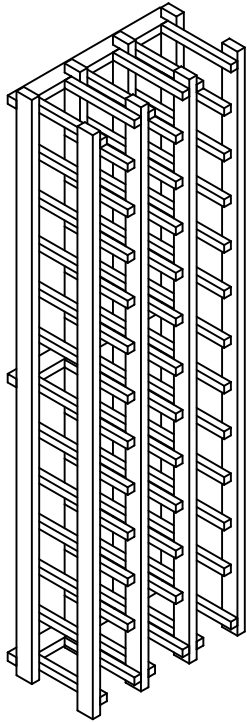

Taller

NOTE FOR WMK: For correct orientation with non-display version, the bottom bottle space of the rack is 3/16" taller than the top bottle space.

2. Attach (1) spacer bar to the front of the racks nailing through the end notches. Then Attach (1) Back Brace at the bottom of the Top Spacerbar and another (1) Back Brace on Top of the Bottom Spacerbar

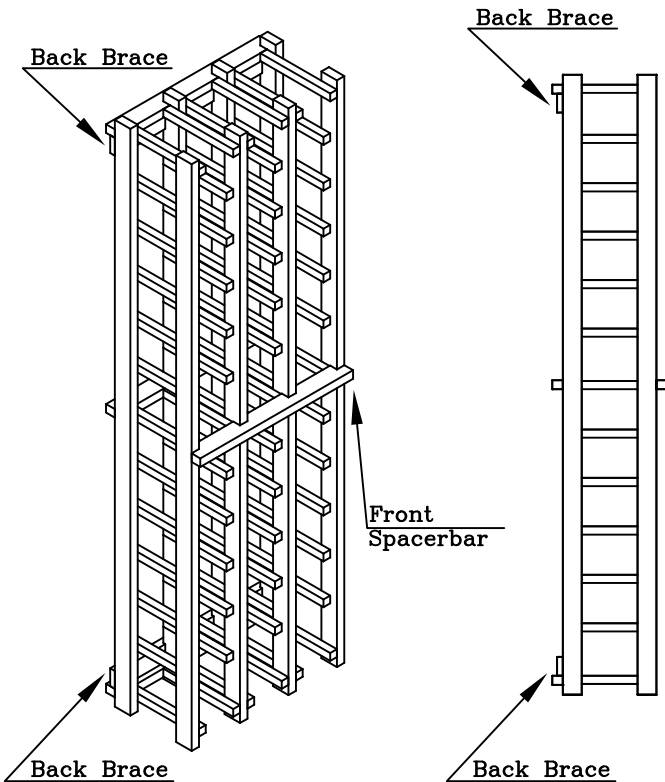

3. Attach Square Crown to front of racks with nails provided. If unit is not going to be stacked on top of another kit then attach Square Base as well. If unit is going to be stacked on top of another kit then follow the trim kit instructions before attaching the bottom trim board.

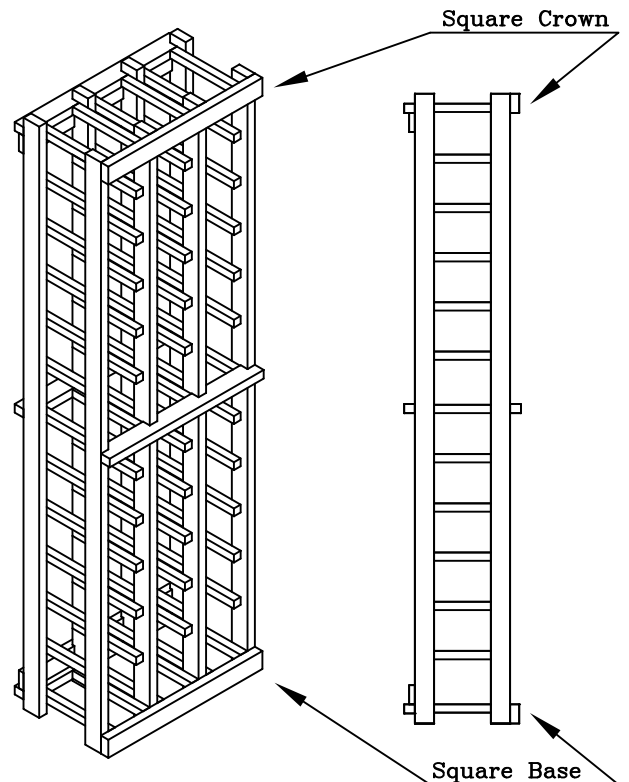

## Final Step

Secure to the Wall

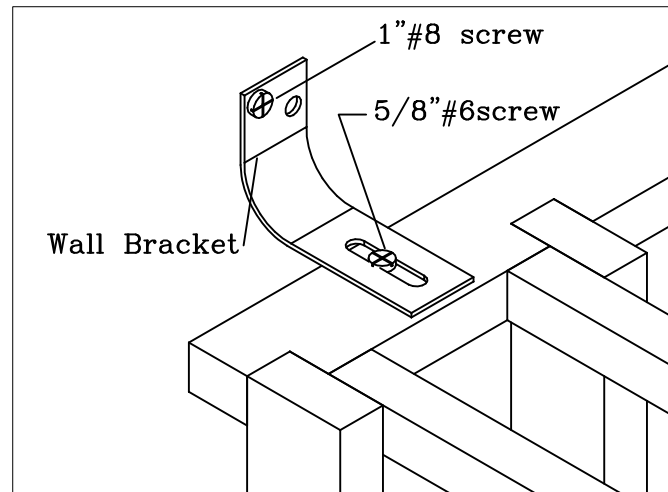

Secure rack to wall by attaching wall brackets to top back spacer bar or solid top. You will have 1 bracket on the left and 1 on the right.

Note :

WMK Racks should be placed 1 1/2" off of the wall

## Wine Rack is Complete

always remove bottles before moving racks.