

Assembly Manual
TR-xx-1COL and RP-xx-1COL
TR-xx-1COLDS and RP-xx-1COLDS

**** 1 Column with Display shown throughout manual ****

TR-xx-1COLDS
PR-xx-1COLDS

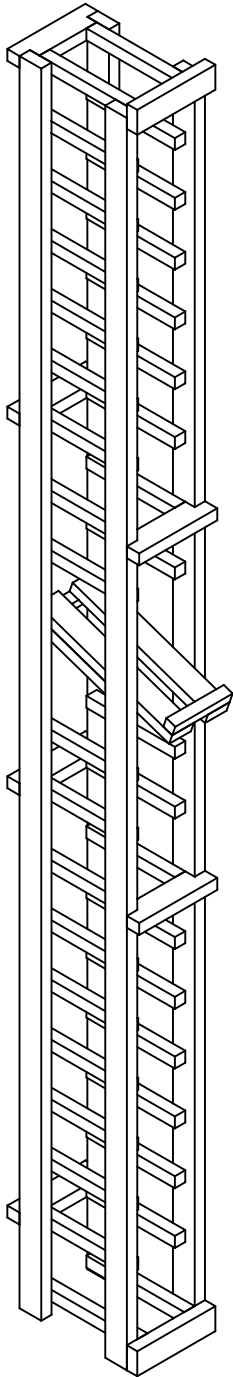

TR-xx-1COL
PR-xx-1COL

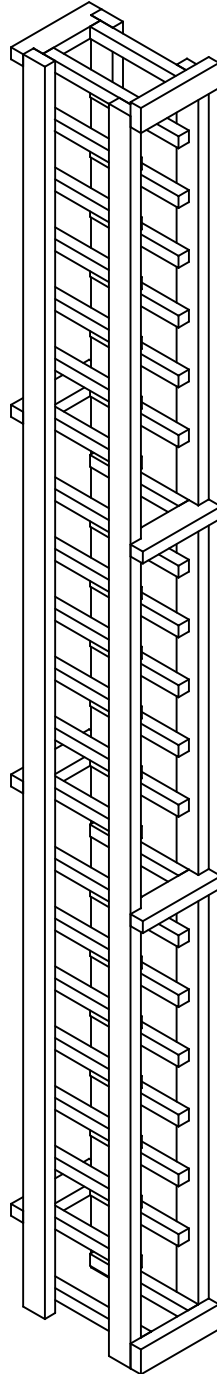

Industry Leading
Replacement Policy :

If during transit or assembly you should break or damage any of the parts you may contact us within 90 days of the ship date and we will ship you a replacement part via ground transportation at no additional cost to you.

Wine Cellar Innovations
4575 Eastern Avenue
Cincinnati, Ohio 45226

Phone: (800) 229-9813
Fax: (513) 979-5280
www.winecellarinnovations.com

Parts List

TR-xx-1COLDS, RP-xx-1COLDS

#	Qty.	#
A	6	2 notch Spacer Bars - 5 3/16
B	2	Top/Bottom Back Brace - 5 3/16
C	2	Square Base/Crown - 5 3/16
D	1	Left Rack - 72
E	1	Right Rack - 72
H	1	Display Tray

TR-xx-1COL, RP-xx-1COL

#	Qty.	#
A	8	2 notch Spacer Bars - 5 3/16
B	2	Top/Bottom Back Brace - 5 3/16
C	2	Square Base/Crown - 5 3/16
F	1	Left Rack - 72
F	1	Right Rack - 72

NOTE : All Racks Parts will Include

*	1	Hardware Pack containing
*	1	Bag of Nails
		2 angle brackets
		2 plastic anchors
		2 1"#8 screws
		2 3/4"#6 screws

**TR-xx-1COLDS
PR-xx-1COLDS**

**TR-xx-1COL
PR-xx-1COL**

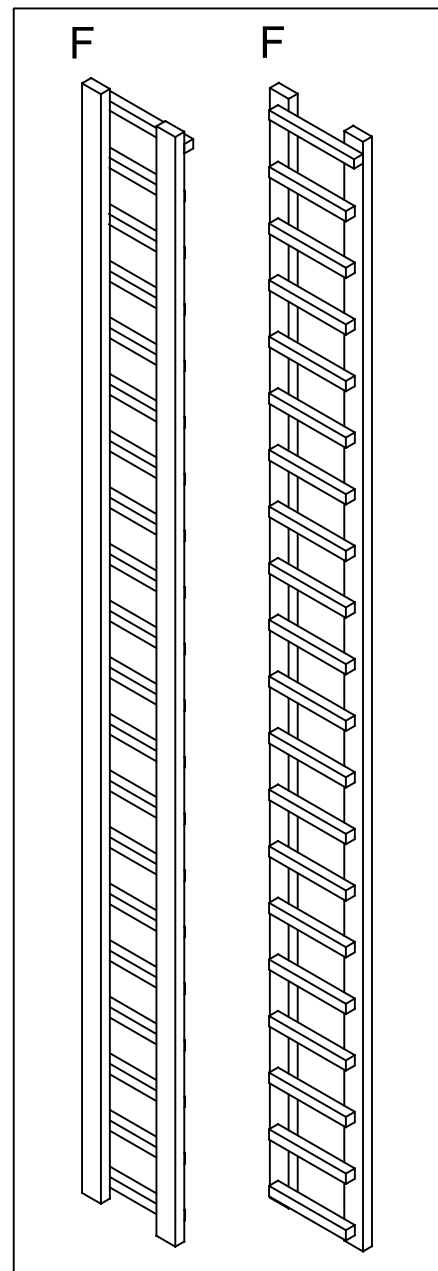
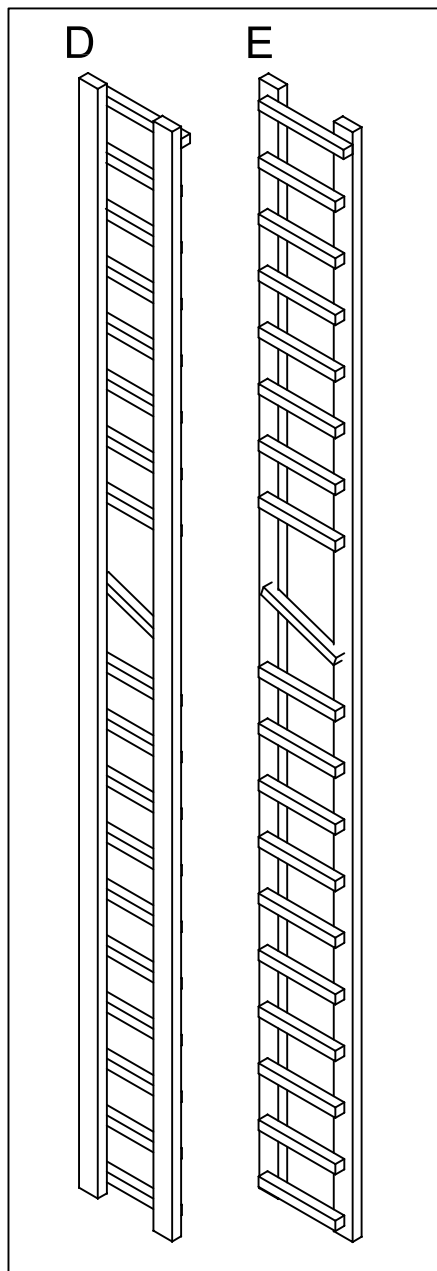
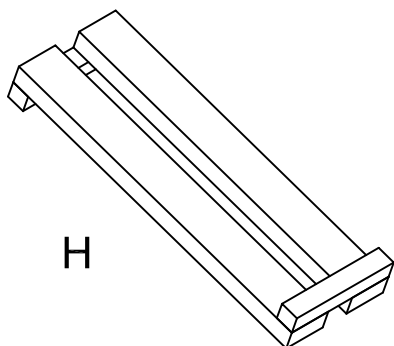
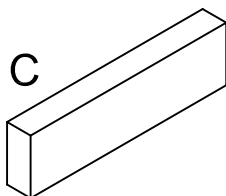
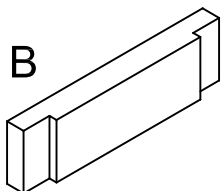
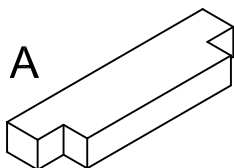

Step 1:

Place 2 end racks on the ground facing up and attach 2 spacerbars, 1 Square Base and 1 Square Crown to the racks with nails. This can be done with the provided nails or with a brad nailer.

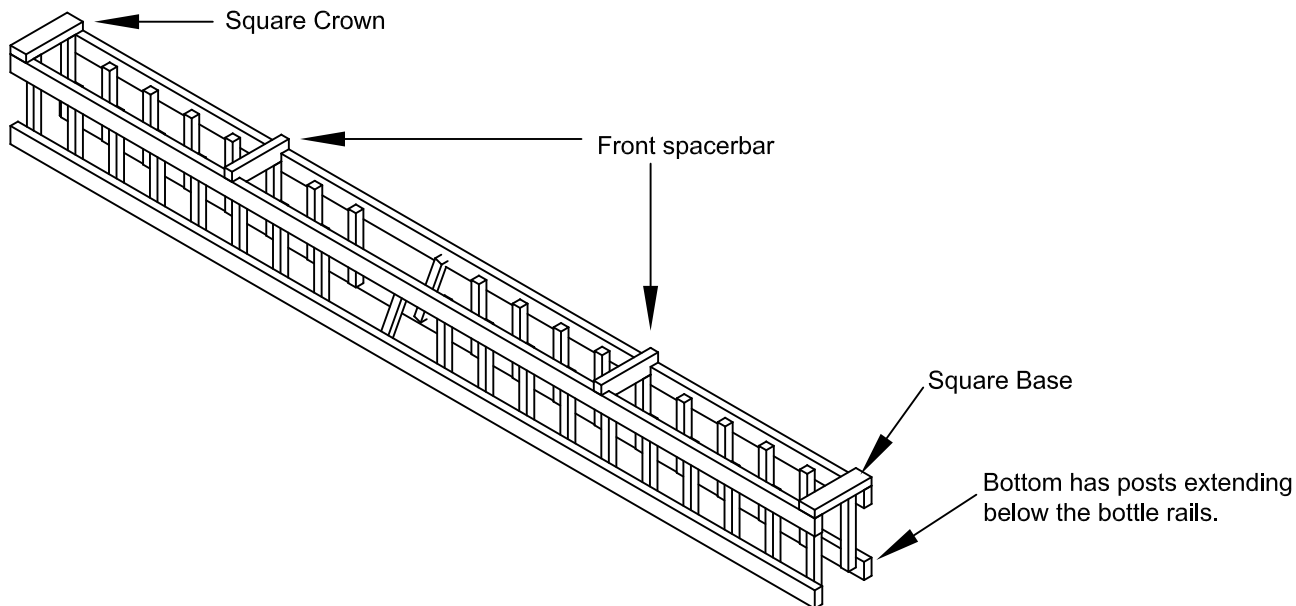

Step 2:

Flip rack over and nail the remaining 4 spacerbars to the racks in the same manner as step 1.

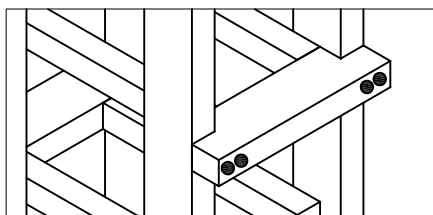
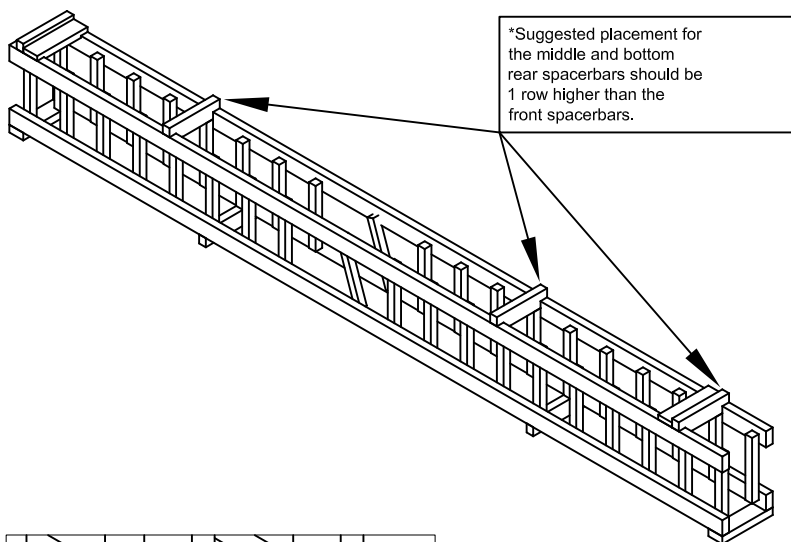

NAIL GUN RECOMMENDED

The rear spacerbars would receive double nailing thru each post.

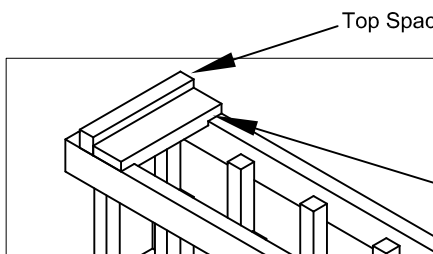

*Attach 1 Back Brace below Top Spacerbar and another on top of Bottom Spacerbar

Back Brace

Step 3: (With Display Only)

Insert display tray from the front of the rack. The back of the tray will slide over the back of the angled bottle rails attached to the racks.

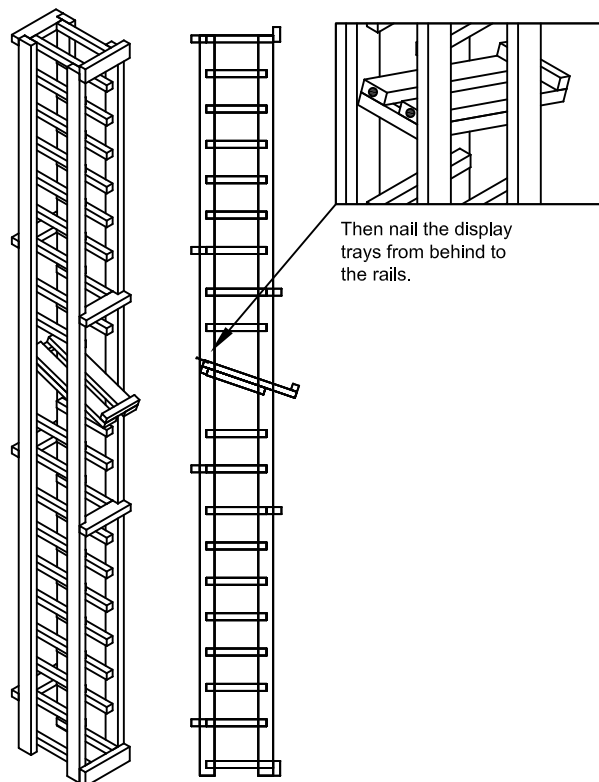

Final Step

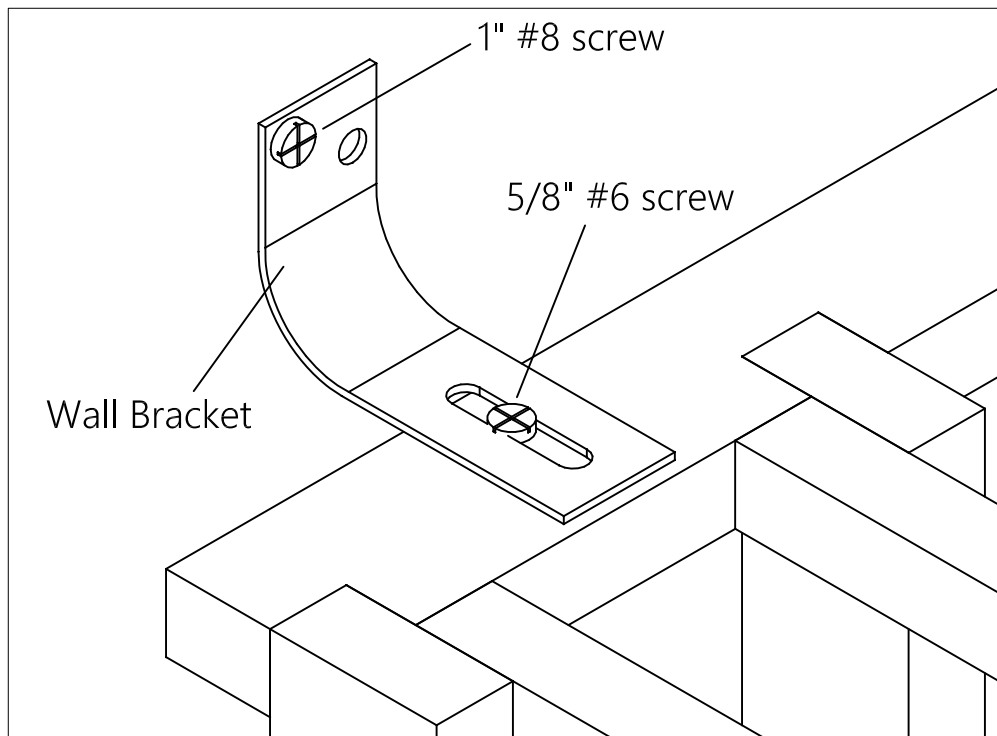

Secure rack to wall by attaching wall brackets to top back spacer bar.
You will have 1 bracket on the left and 1 on the right.

RACK ASSEMBLY IS COMPLETE.
Always remove bottles before moving racks.

For more info
Watch Assembly Videos in our Video Gallery at www.WineCellarInnovations.com