

Vintner Series

Rev. 6/30/08

Individual 2 column

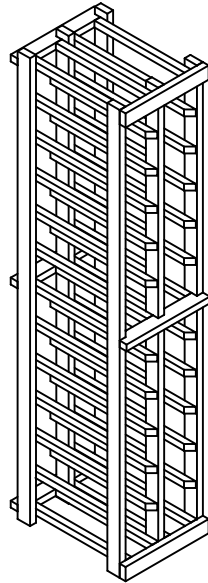

VIN-IND2

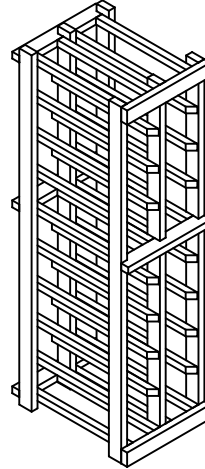

VIN3-IND2

Note: The VIN-IND2 is detailed in this manual however the assembly procedure for VIN-IND2 and VIN3-IND2 kit is the same.

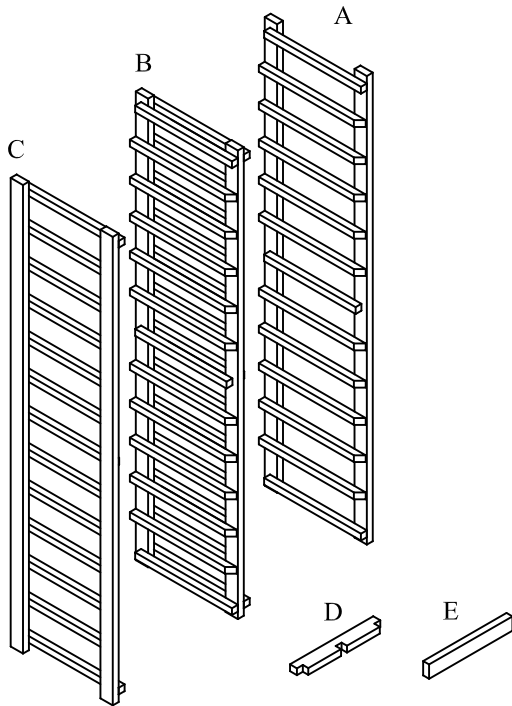

Parts List

| # | qty. | description |
|---|------|--|
| A | 1 | Right Rack |
| B | 1 | Double Racks |
| C | 1 | Left Rack |
| D | 4 | Spacer bars |
| E | 2 | Top/ Bottom Trim |
| * | 1 | Bag of nails |
| * | 1 | Hardware Pack containing 2 1" Corner Brace 2 plastic anchors 2 1" #8 screws 2 5/8" #6 screws |

1. Attach (3) spacer bars to the back of the racks with nails.

Top & bottom spacer bars should only have a nail on each end, the middle spacer bar should have a nail in each notch. This can be done with the provided nails or with a brad nailer.

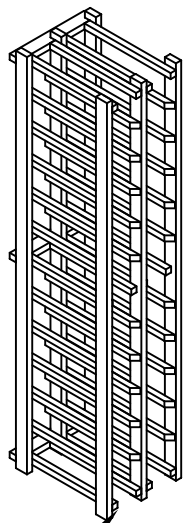

bottom and top rails
are not recessed on front
of rack

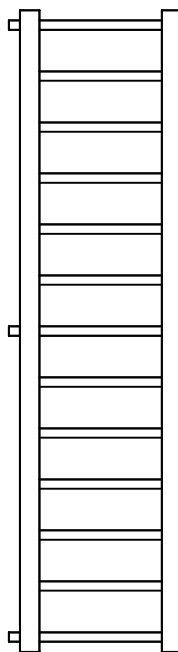

2. Attach a spacer bar to the front of the racks by nailing through the end notches.

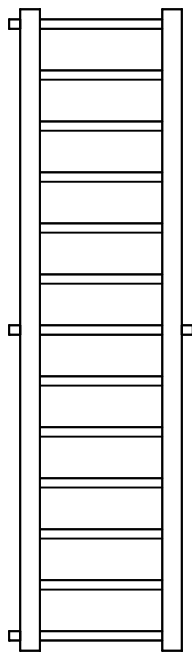
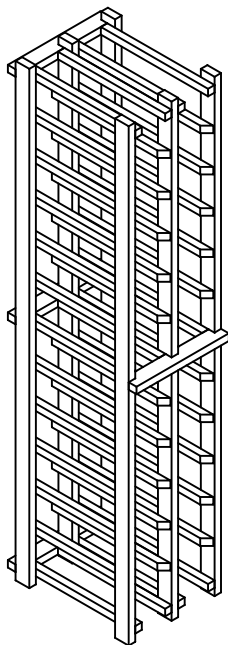

3. Attach top trim to front of racks with nails provided. If unit is not going to be stacked on top of another kit then attach bottom trim as well. If unit is going to be stacked on top of another kit then follow the trim kit instructions before attaching the bottom trim board.

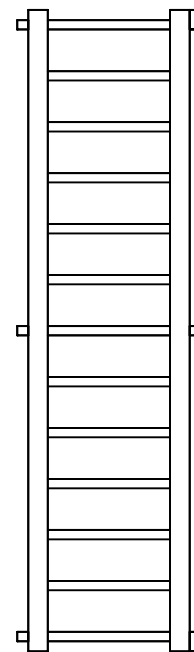
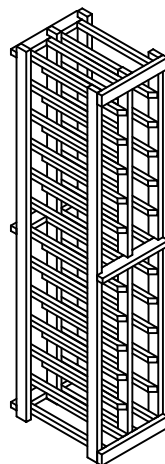

Final Step

Securing to wall



Note: due to ceiling height restrictions it may be necessary to attach Corner brace on under side of Spacer bar.

Secure rack to wall by attaching 1" corner brace to top back spacer bar (or solid top) of unit. You will have 1 brace on the left and 1 on the right.

If you are securing a kit that is stacked on top of another unit follow the instructions for installing trim kit before attaching to wall.

Attach the corner braces to one of the middle spacer bars, if you have a bin unit or diamond cube unit that will have other racks stacked on top of it.