

Premium Clear Redwood 3 Column Magnum

Rev. 4/18/08

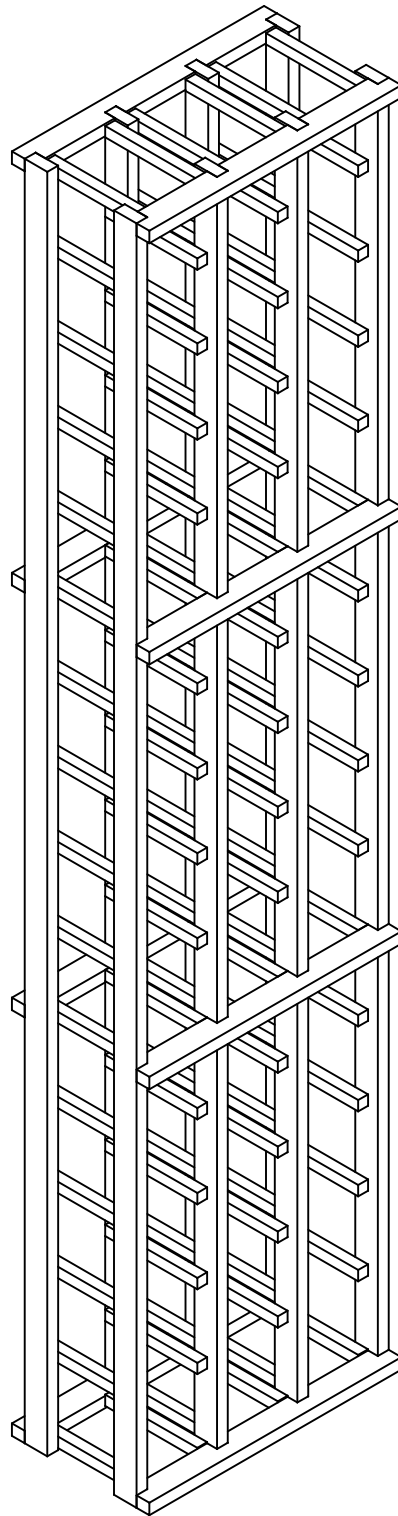

Wine Cellar Innovations
4575 Eastern Avenue
Cincinnati, Ohio 45226

Phone: (800) 229-9813
Fax: (513) 979-5280
www.winecellarinnovations.com

Parts List

Rev. 4/18/08

#	Qty.	Description
A:	8	Spacer Bars
B:	2	End Racks
C:	2	Double Racks
*	1	Bag of nails
*	1	Hardware Pack containing 2 angle brackets 2 plastic anchors 2 1" #8 screws 2 3/4" #6 screws

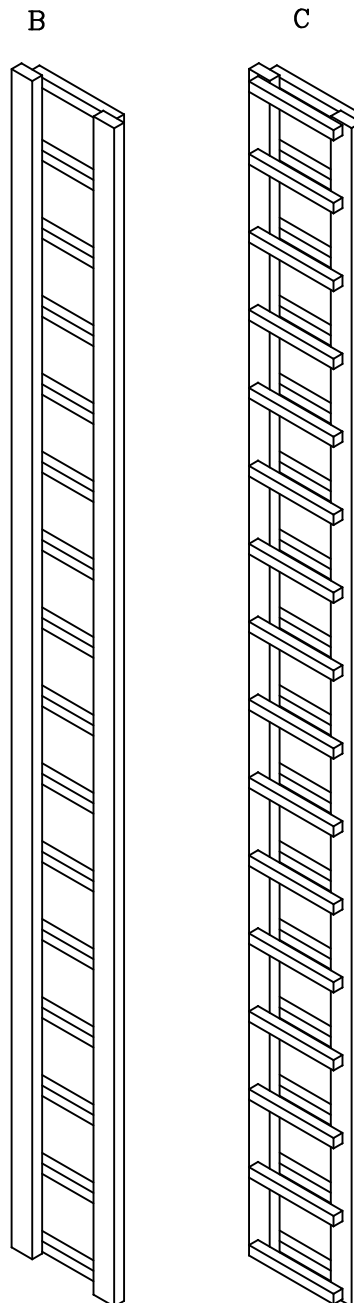
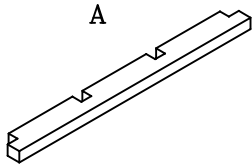

Step 1:

- a. Place 4 spacer bars on the floor staggered with notches facing up.

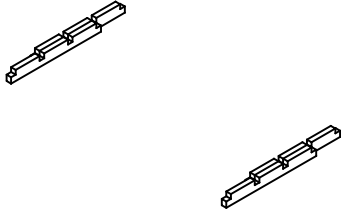

- b. Place (2) end and (2) double racks on the staggered spacer bars.

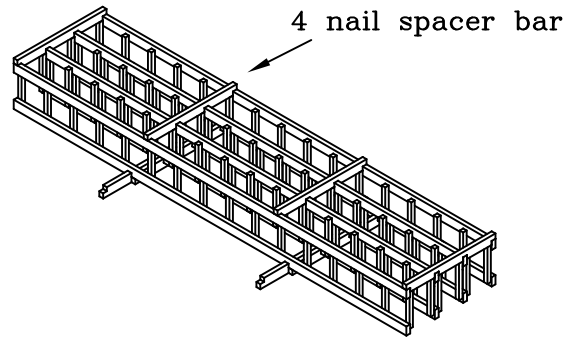

This position is temporary DO NOT nail staggered Spacer bars to racks.

- c. Attach (4) spacer bars to racks with nails

Nail the nails into each spacer bar just on each end except the noted 4 nail spacer bar. This can be done with the provided nails or with a brad nailer.

Step 2:

Stand racks upright, remove (4) staggered spacer bars from floor and nail to other side of racks in the same manner as above.

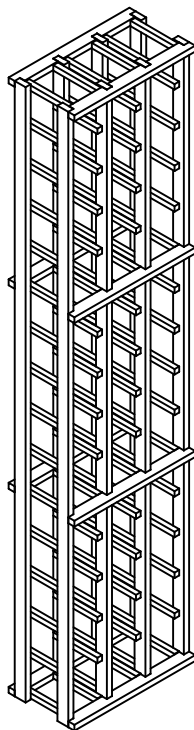

Final Step

Securing to wall

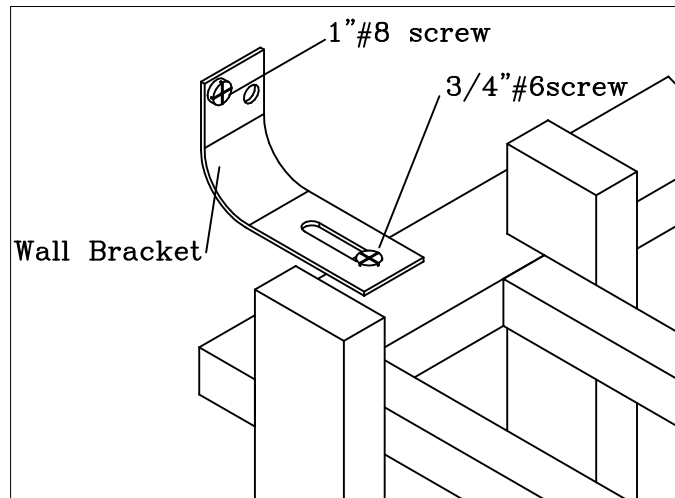

Secure rack to wall by attaching wall brackets to top back spacer bar or solid top. You will have 1 bracket on the left and 1 on the right.

Wine Rack is Complete

Note: Always remove bottles before moving rack.