

Vintner Series

Rev: 1/20/12

Curved Trim Kit

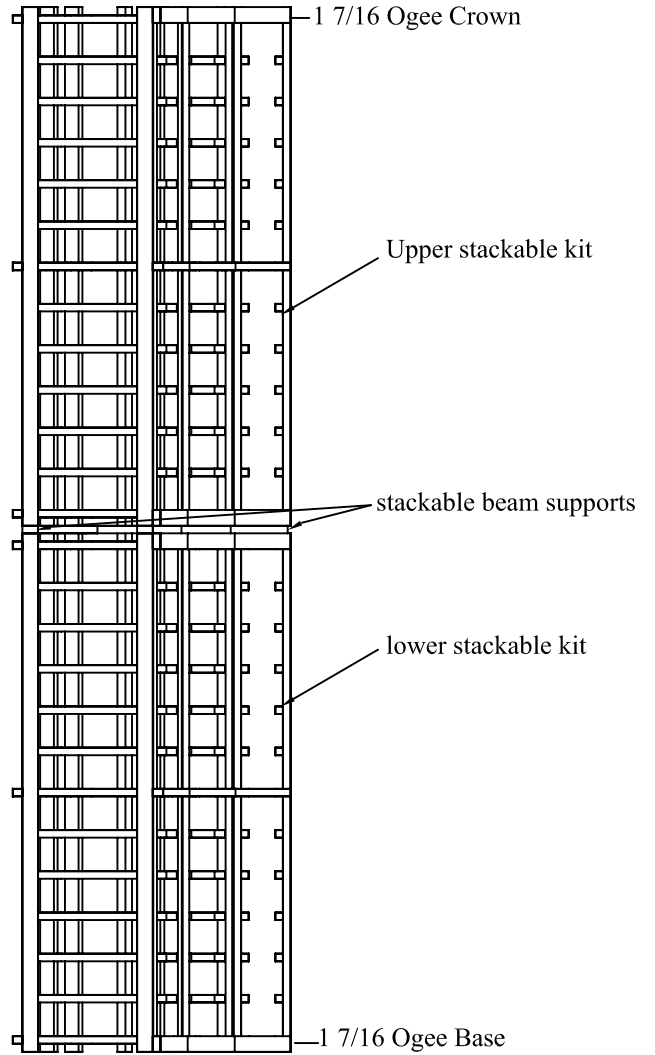
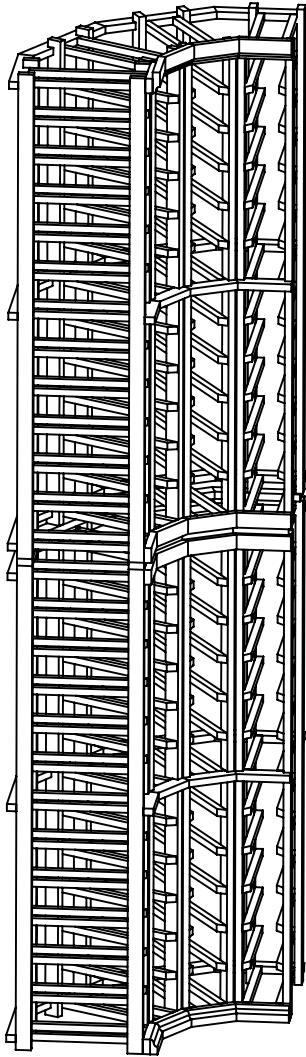

stackable beam supports Included with curved rack

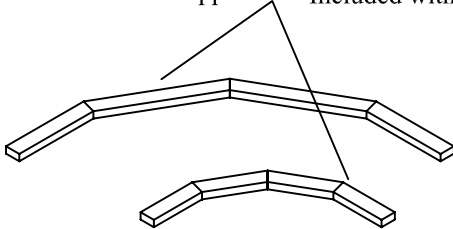

Standard Curved Trim Kit includes:

- | | |
|---|--------------------------|
| 1 | Curved 1 7/16 Ogee Crown |
| 1 | Curved 1 7/16 Ogee Base |
| 1 | Bag of Nails |

Kit may contain additional moldings depending on order.

Note: the following installation instructions show standard kit option. Assembly is the same for all types of molding except where noted otherwise.

Molding options: Kit may contain one or more of the following Depending on purchase.

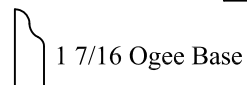
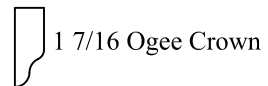
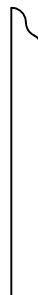
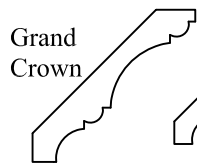
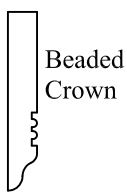
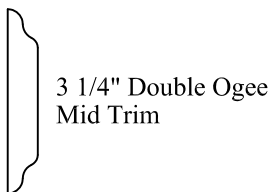

Wine Cellar Innovations
4575 Eastern Avenue
Cincinnati, Ohio 45226

Phone: (800) 229-9813
Fax: (513) 979-5280
www.winecellarinnovations.com

1.
Attach stackable beam supports to bottom of upper kit.

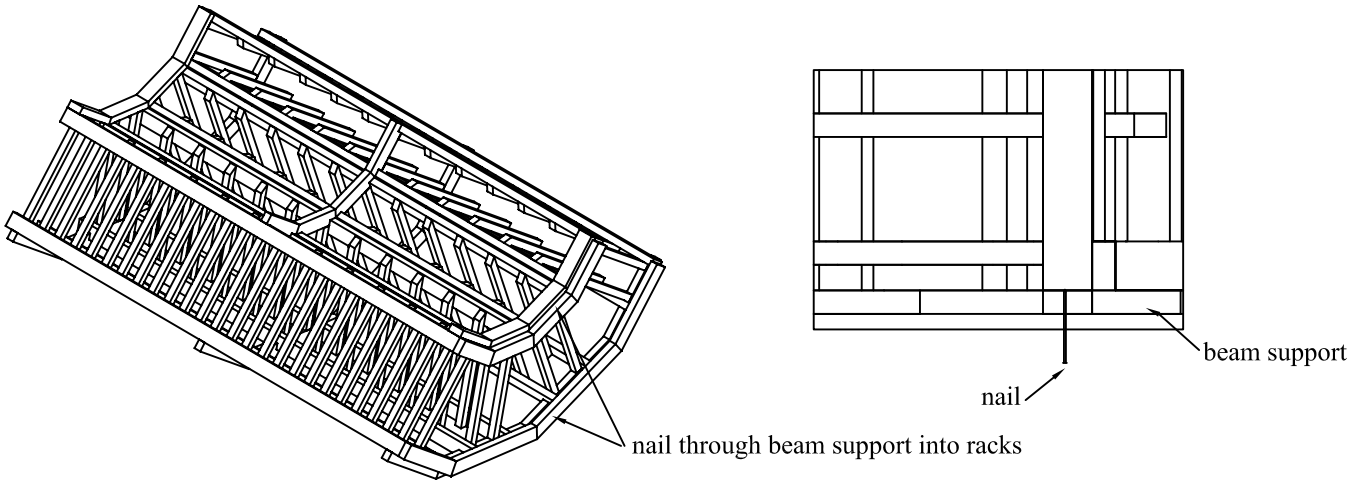

2.
Place upper kit on top of lower kit.

Make sure upper and lower kits are attached to the wall using angle brackets.

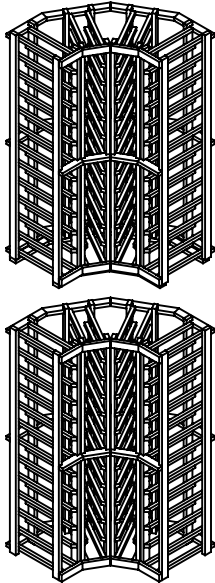

3.
Attach OG crown, OG base and bottom trim of upper kit to racks with nails provided.

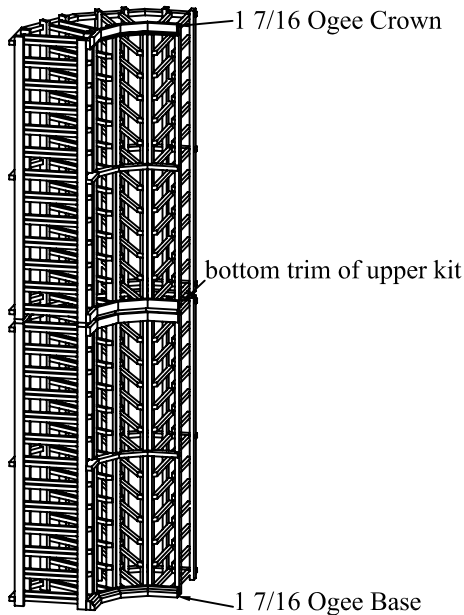

For Mid trim option:
Attach mid trim to bottom trim of upper kit and upper trim of lower kit.

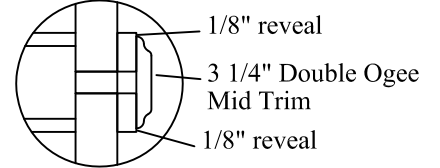

For 5 1/4\" base option:
Place kits on top of 3 13/16\" tall platform, attach base to front of platform and front trim of lower kit.

