

# Commercial Display Racking

Radius Curved Corner Display

Rev: 4/16/10

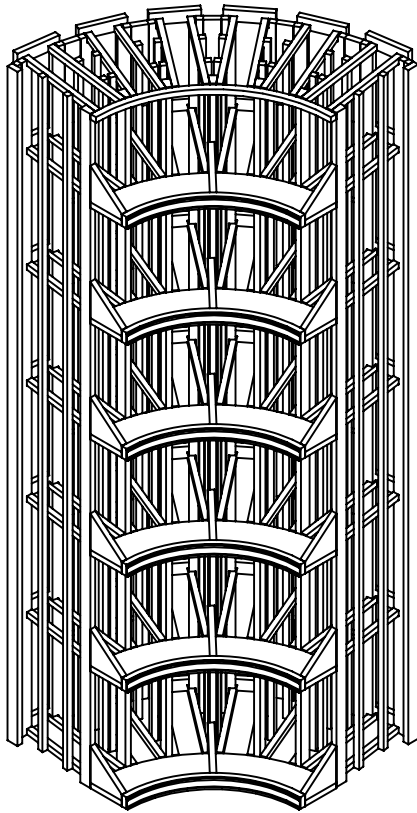

Front View

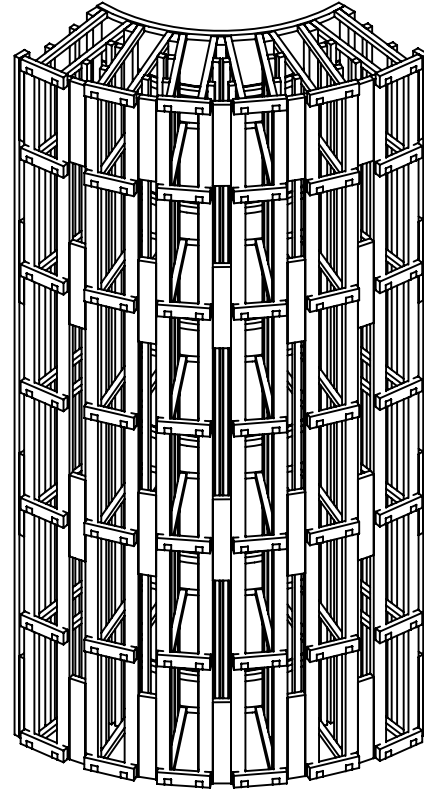

Back View

Thank you for your purchase from Wine Cellar Innovations. In the manufacturing and packaging of your products numerous people have reviewed your order for accuracy and attention to detail. We believe this focus is what has made us the worldwide leader in wine storage products.

When assembling the products, please refer to the instructions provided and follow them closely. Always pre-drill pieces any time a screw will be used as a fastener. Redwood is a soft and beautiful wood species, but will split like all other wood types if placed under unusual stresses. The cellar has been engineered with the weight of the bottles factored into the layout, and will be capable of sustaining loads far greater than this when assembled correctly.

If you happen to break a piece during installation we will replace it for free. In such a situation, feel free to contact us Monday through Friday between 8am and 5pm Eastern time.

**Wine Cellar Innovations**  
4575 Eastern Avenue  
Cincinnati, Ohio 45226

Phone: (800) 229-9813  
Fax: (513) 979-5280  
[www.winecellarinnovations.com](http://www.winecellarinnovations.com)

# Radius Curved Corner Display

Rev: 4/16/10

## Parts List

Qty.	Description
1	Rack- Left
5	Rack- Doubles
1	Rack- Right
1	Curved Corner Connector
6	Spacer Bar Display Shelf
42	Spacer Bars
18	Spacer Bar Jigs
23	Right Angle Brackets
12	Connecting Brackets
74	3/4" #6 Screw
20	3" #8 Screw
1	Bag of Nails
1	Hardware Pack containing 2 angle brackets 2 plastic anchors 2 1" #8 screws 2 5/8" #6 screws

Curved Corner Connector

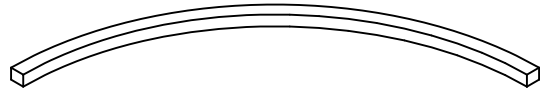

Curved Display Shelf  
w/3 triangular supports per shelf

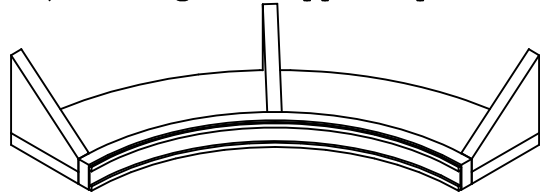

\*\* Optional pricetrack shown \*\*

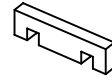

Spacer Bars

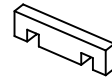

Spacer Bar Jigs

\* Jigs and spacer bars are the same but jigs are used for setup only.

## Racks

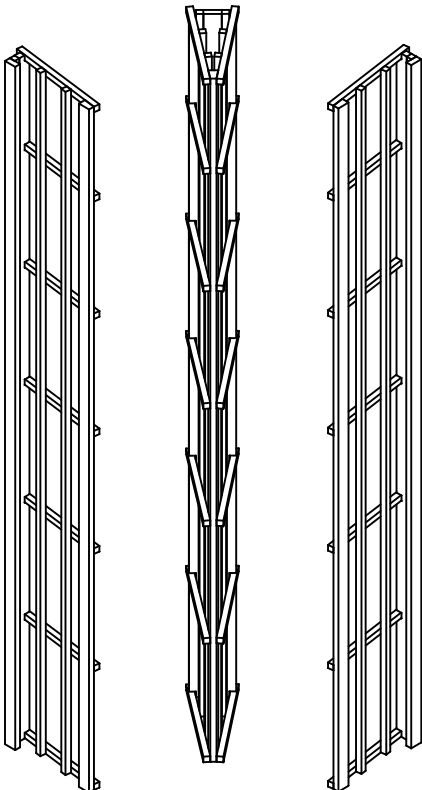

Left

Doubles

Right

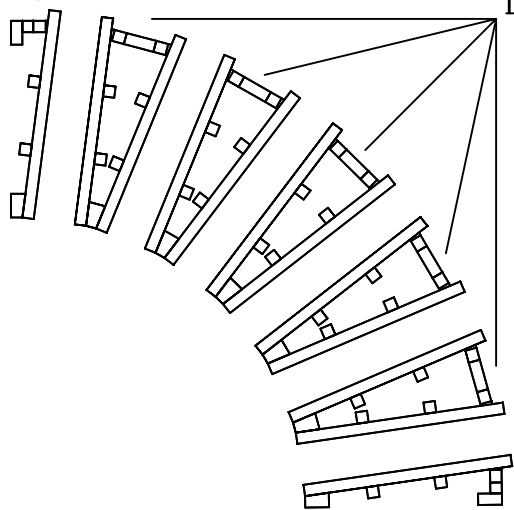

### Step 1:

Spacer bars lock the back together and are permanent

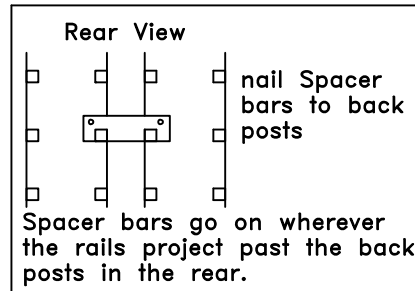
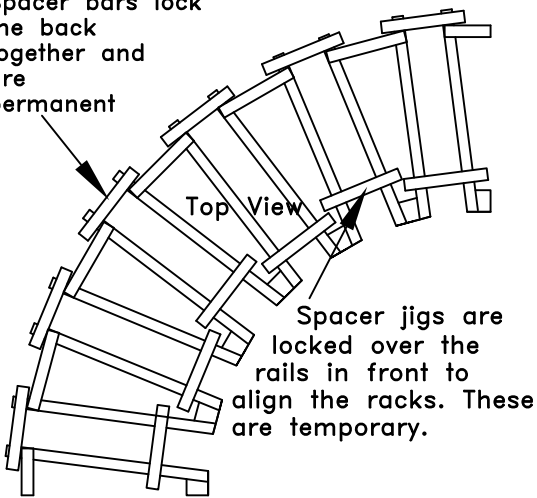

Note: Spacer bars and spacer jigs are the same pieces but they serve different functions. Only one set of spacer jigs is provided for all the curved corners.

### Step 2:

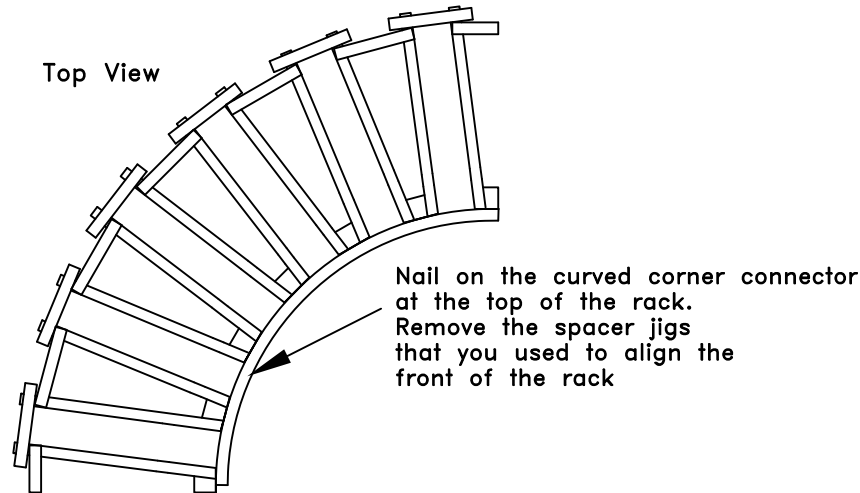

### Step 3:

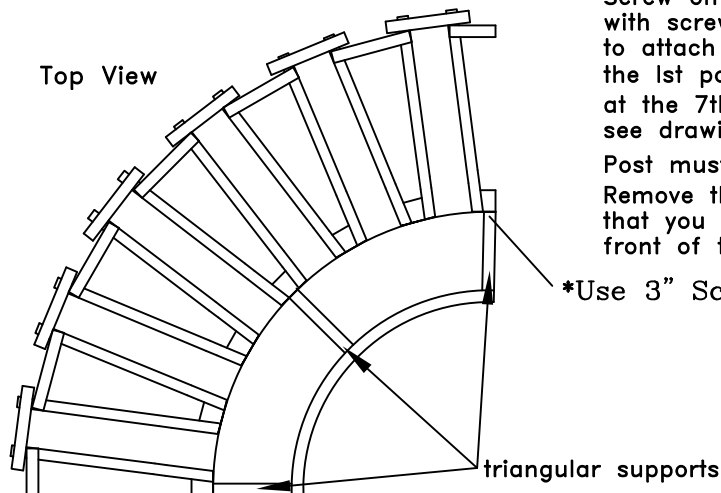

Screw on curved display shelves with screws provided. You will need to attach (1) triangular support at the 1st post, at the 4th post, and at the 7th post. see drawing provided.

Post must be predrilled first using a 1/8" drill bit. Remove the spacer jigs that you used to align the front of the rack

Step 4:

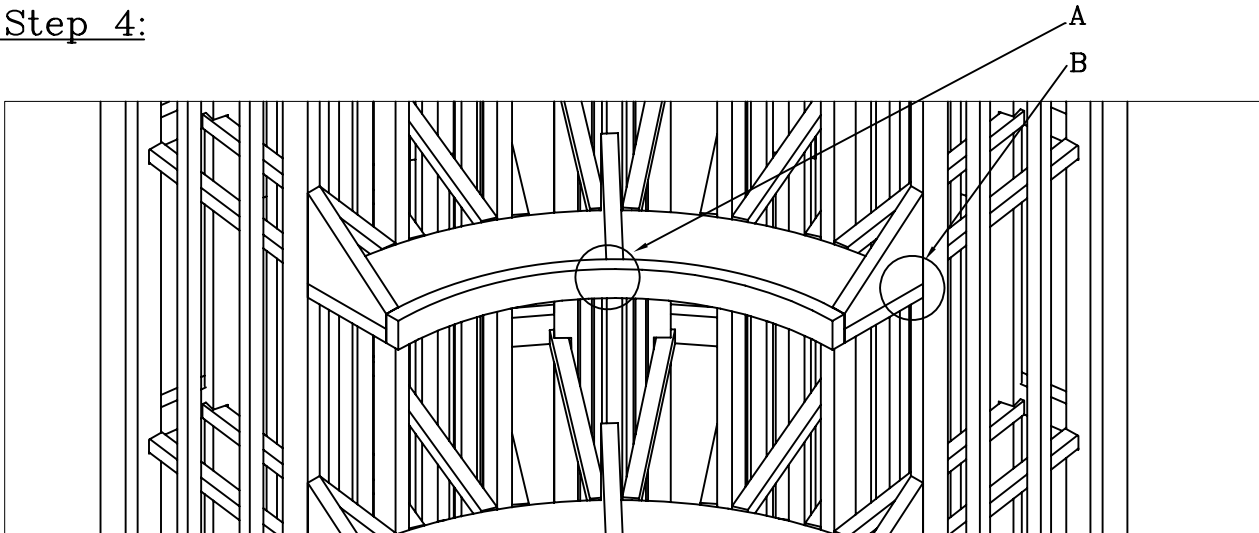

- A. Attach angle brackets to front post and shelf at the ends and center. (no brackets on bottom shelf)

The second display shelf up from the bottom and the second shelf down from the top should have an angle bracket attached to each post underneath the shelf. (7 per shelf)

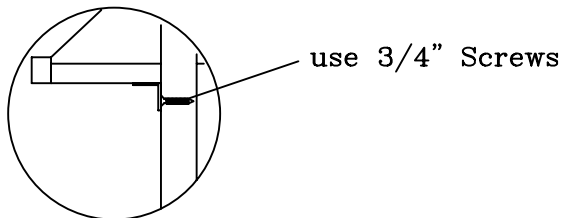

- B. Attach Connecting brackets to right and left ends of display shelves

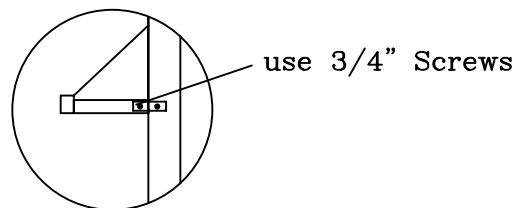

5. (Optional)

Secure racks on either side of curved corner unit by nailing through the vertical end post on adjoining units.

For Curved corners without racks on either side; Secure rack to wall by attaching wall brackets to vertical end posts. You will have 1 bracket on the left and 1 on the right.

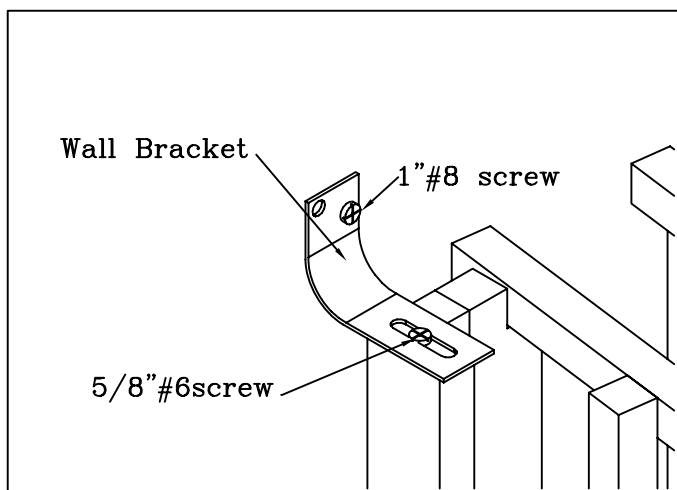

Radius Curved Corner Display assembly now complete.

Always remove bottles before moving racks.

**Wine Cellar Innovations**  
4575 Eastern Avenue  
Cincinnati, Ohio 45226

Phone: (800) 229-9813  
Fax: (513) 979-5280

[www.winecellarinnovations.com](http://www.winecellarinnovations.com)