

Designer Series

Rev. 5/28/08

Individual 3 Column

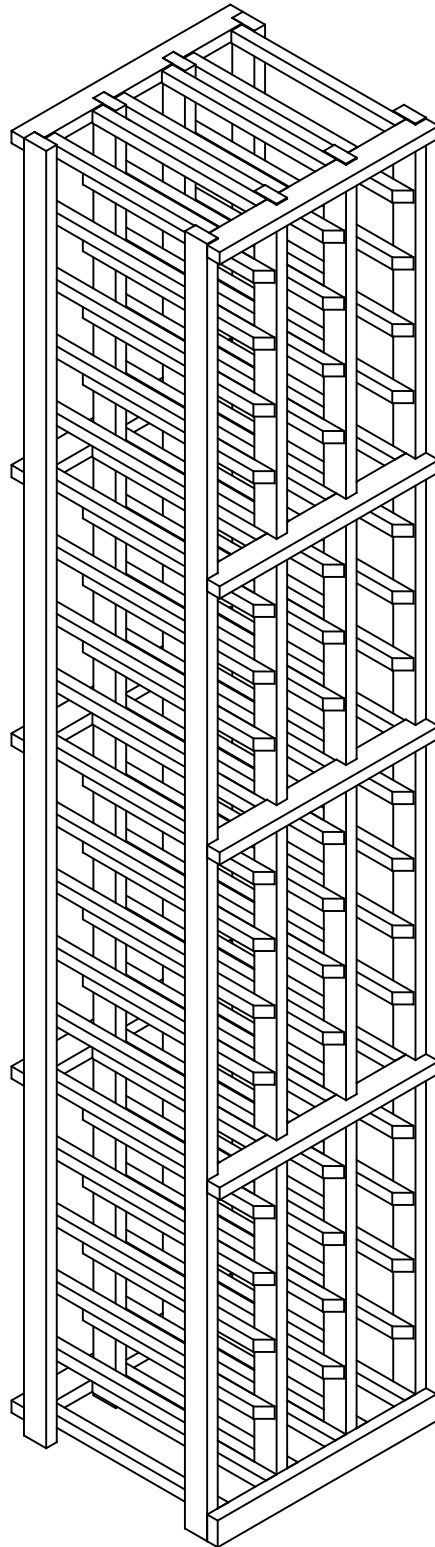

Wine Cellar Innovations
4575 Eastern Avenue
Cincinnati, Ohio 45226

Phone: (800) 229-9813
Fax: (513) 979-5280
www.winecellarinnovations.com

Individual 3 Column

Rev. 5/28/08

Parts List

#	qty.	description
A	1	Left
B	2	Doubles
C	1	Right
D	9	Spacer Bars
E	1	Sq. Cut Base
*	1	Bag of nails
*	1	Hardware Pack containing 2 angle brackets 2 plastic anchors 2 1" #8 screws 2 5/8" #6 screws

A

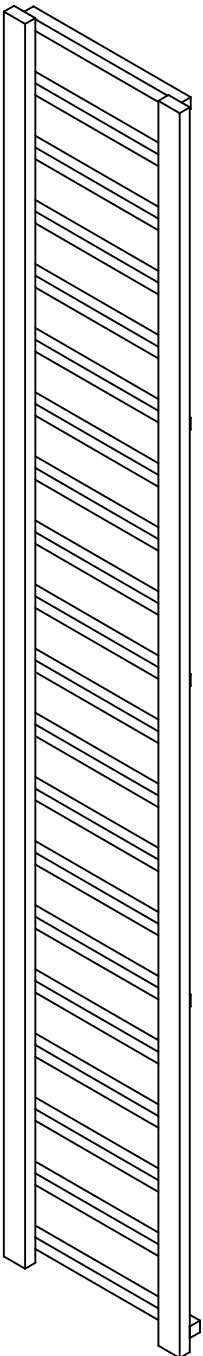

B

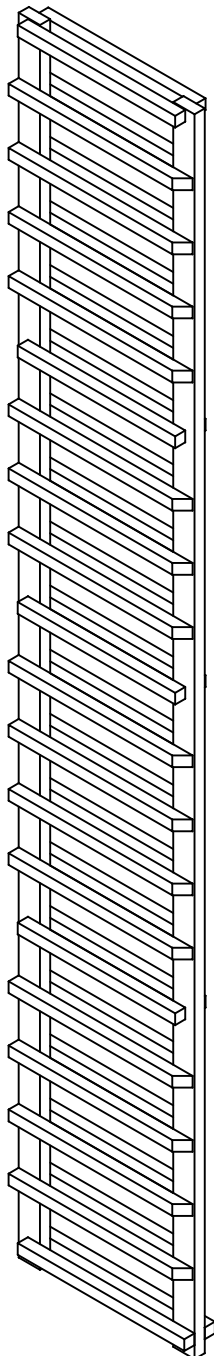

C

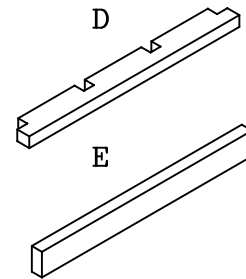
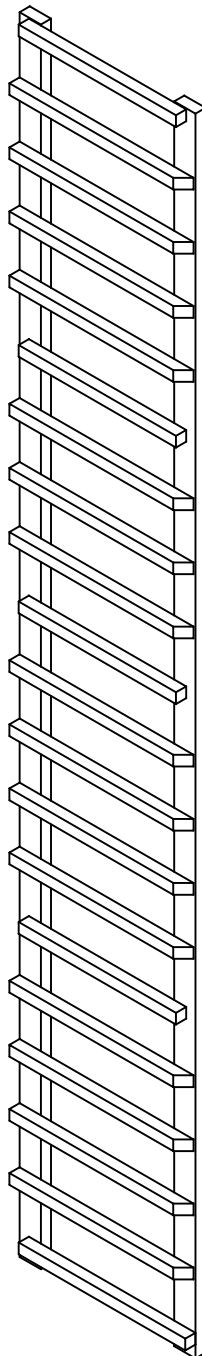

1.

Attach (5) spacer bars to back of racks with nails

Nail through all notches into the post on one middle spacer bar, you only need to nail through end notches on remaining spacer bars. This can be done with the provided nails or with a brad nailer.

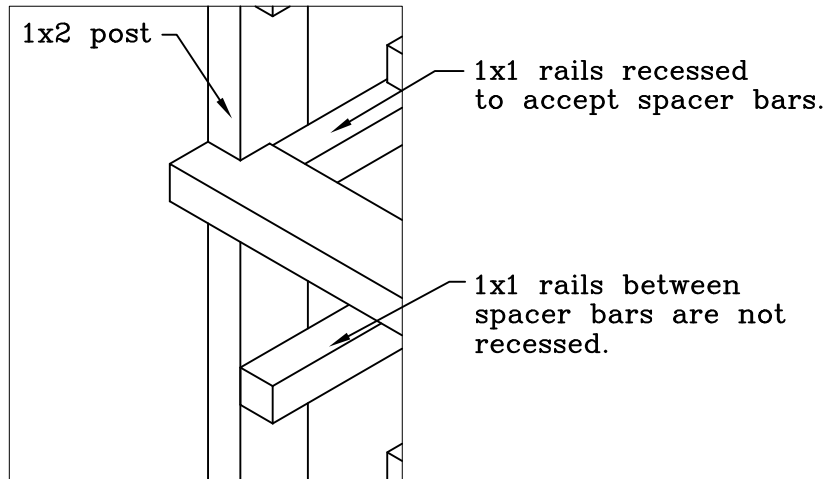
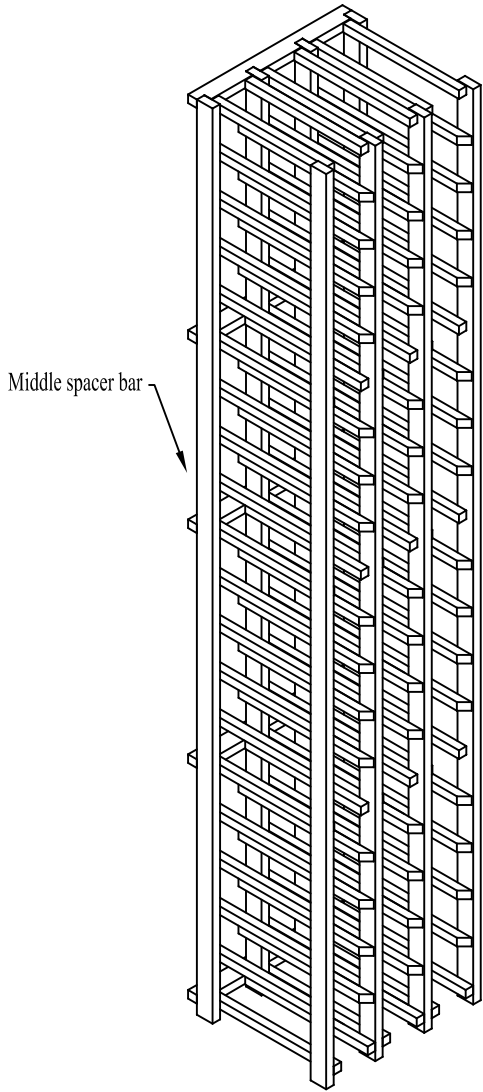

2. Attach (4) spacer bars to the front of the racks in the same manner as the back.

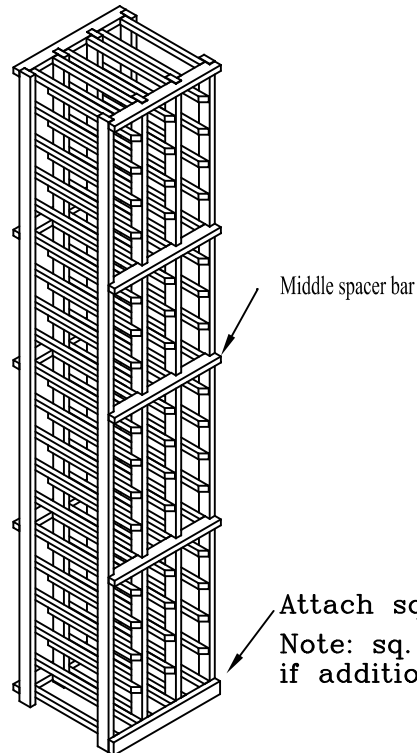

3.

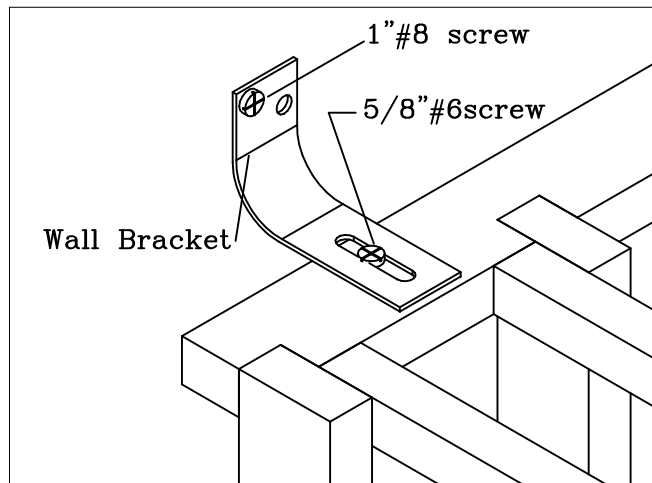

Secure rack to wall by attaching wall brackets to top back spacer bar. You will have 1 bracket on the left and 1 on the right.

Individual 3 column
assembly complete.

always remove bottles before moving racks.

Wine Cellar Innovations
4575 Eastern Avenue
Cincinnati, Ohio 45226

Phone: (800) 229-9813
Fax: (513) 979-5280
www.winecellarinnovations.com