

# Designer Series

Rev. 5/28/08

## Individual 3 Column Magnum

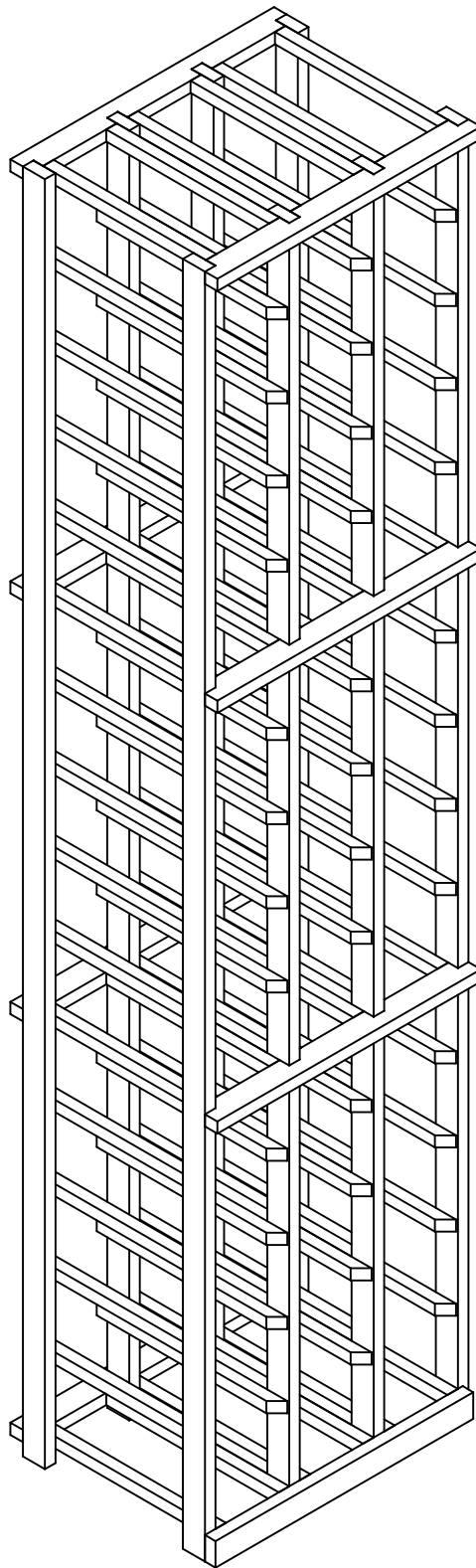

**Wine Cellar Innovations**  
4575 Eastern Avenue  
Cincinnati, Ohio 45226

Phone: (800) 229-9813  
Fax: (513) 979-5280  
[www.winecellarinnovations.com](http://www.winecellarinnovations.com)

# Individual 3 Column Magnum

Rev. 5/28/08

## Parts List

#	qty.	description
A	1	Left
B	2	Doubles
C	1	Right
D	7	Spacer Bars
E	1	Sq. Cut Base
*	1	Bag of nails
*	1	Hardware Pack containing 2 angle brackets 2 plastic anchors 2 1" #8 screws 2 5/8" #6 screws

A

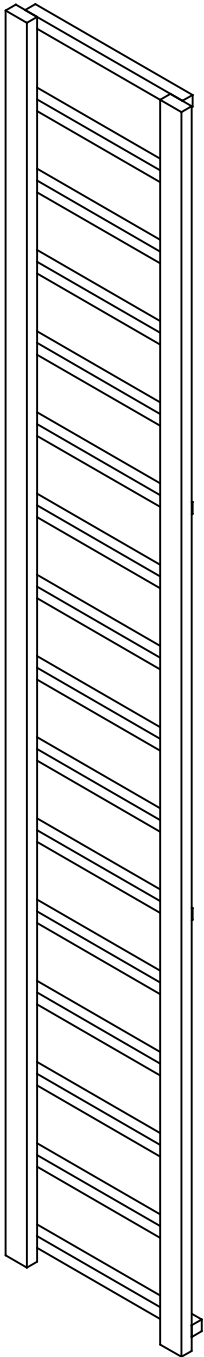

B

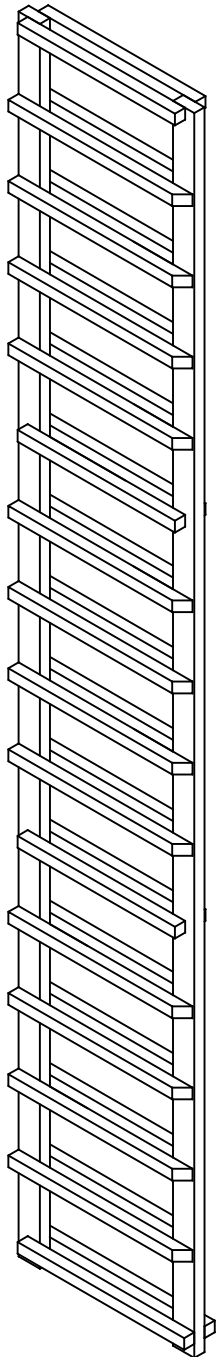

C

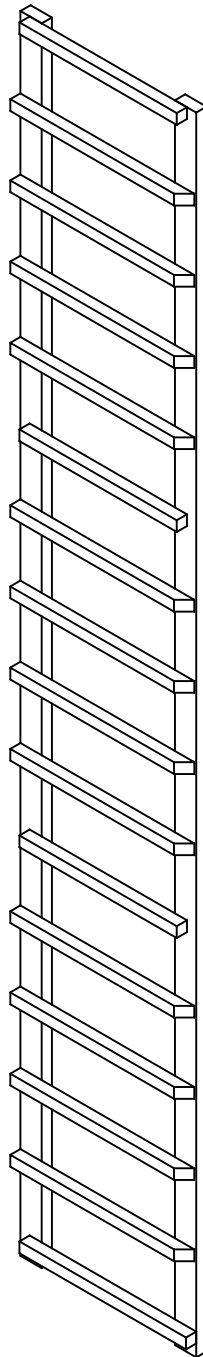

D

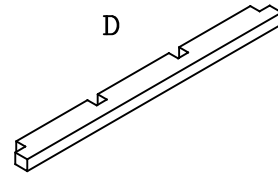

E

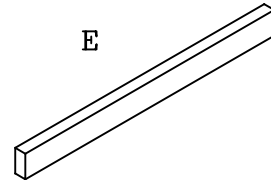

1. Attach (4) spacer bars to back of racks with nails

Nail through all notches into the post on one middle spacer bar, you only need to nail through end notches on remaining spacer bars. This can be done with the provided nails or with a brad nailer.

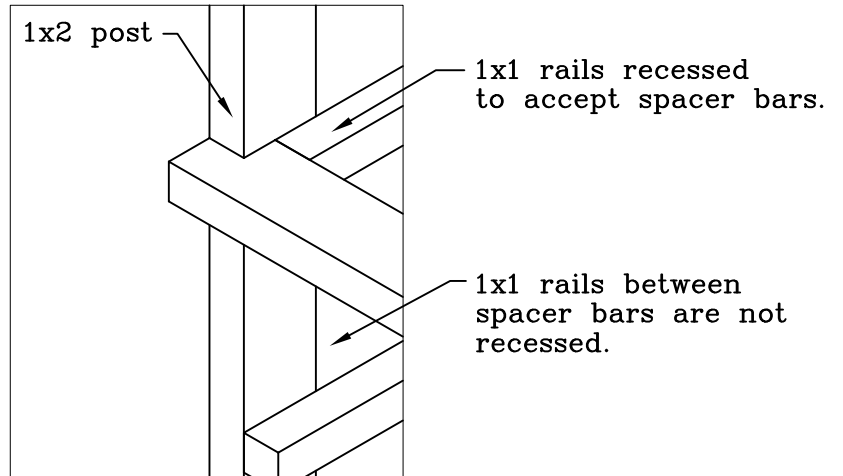
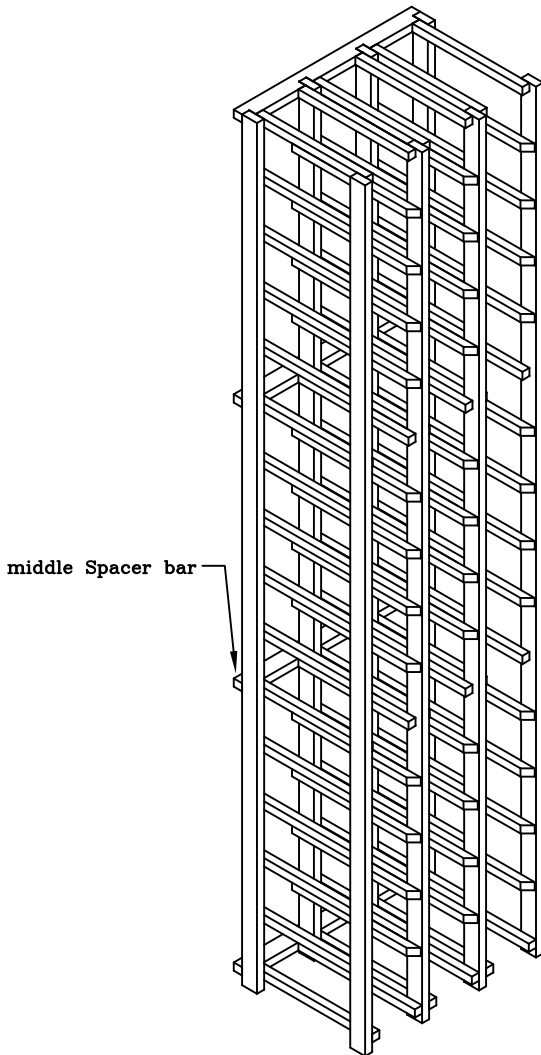

2. Attach (3) spacer bars to the front of the racks in the same manner as the back.

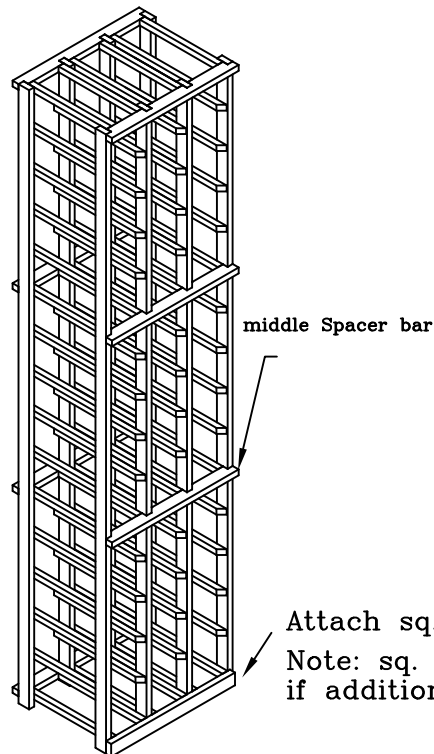

Attach sq. cut base

Note: sq. cut base will not be used if additional base kit is purchased

3.

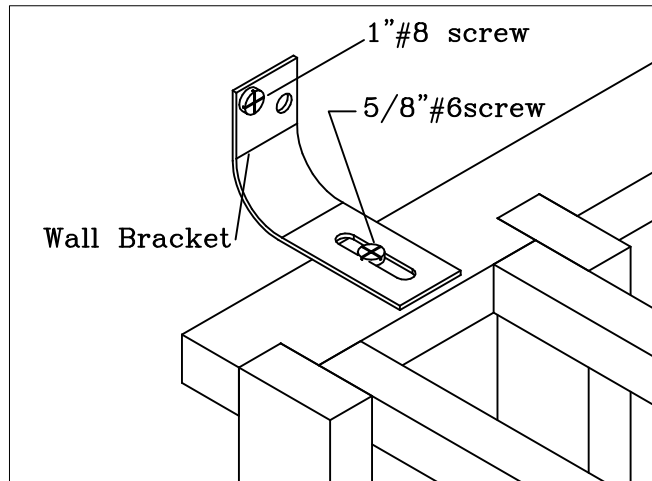

Secure rack to wall by attaching wall brackets to top back spacer bar. You will have 1 bracket on the left and 1 on the right.

Individual 3 column magnum assembly complete.

always remove bottles before moving racks.

**Wine Cellar Innovations**  
4575 Eastern Avenue  
Cincinnati, Ohio 45226

Phone: (800) 229-9813  
Fax: (513) 979-5280  
[www.winecellarinnovations.com](http://www.winecellarinnovations.com)